



# W-RACING TEAM - FUN CUP

ANNEXE III - RÉVISION 04 (24-01-2024)

Pour les moteurs essence EVO 3



A) Voiture vue de 3/4 avant  
Car seen from 3/4 front



B) Voiture vue de 3/4 arrière  
Car seen 3/4 rear



## 1. GÉNÉRALITÉS/GENERAL

101. Constructeur Manufacturer			<u>W RACING TEAM</u>					
102. Dénomination commerciale Commercial name			<u>FUN CUP EVO 3</u>					
103. Cylindrée Cylinder capacity			<u>1983</u> cm <sup>3</sup>					
104. Mode de construction Type of car construction	a) Mode Type	<table border="1"> <tr> <td><input type="checkbox"/></td> <td>séparée separated</td> <td><input checked="" type="checkbox"/></td> <td>monocoque unitary construction</td> </tr> </table>	<input type="checkbox"/>	séparée separated	<input checked="" type="checkbox"/>	monocoque unitary construction	b) Matériaux du châssis/coque Material of chassis/Bodyshell	<u>STEEL</u>
<input type="checkbox"/>	séparée separated	<input checked="" type="checkbox"/>	monocoque unitary construction					
105. Nombre de volumes Number of volumes			<u>3</u>					
106. Nombre de places Number of places			<u>1 OR 2</u>					

## 2. DIMENSIONS, POIDS/DIMENSIONS, WEIGHT

201. Longueur hors-tout Overall length			<u>3850</u> mm +/- 1%		
202. Largeur hors-tout Overall width			<u>1740</u> mm +/- 1%		
203. Endroit de mesure Where measured			<u>In front of rear wheels</u>		
204. Largeur de carrosserie Width of bodywork	a) À la hauteur de l'axe avant At front axle	<u>1645</u> mm +/- 1%	b) À la hauteur de l'axe arrière At rear axle	<u>1705</u> mm +/- 1%	
205. Empattement Wheelbase			<u>2410</u> mm +/- 1%		
206. Porte-à-faux Overhang	a) Avant Front	<u>665</u> mm +/- 1%	b) Arrière Rear	<u>785</u> mm +/- 1%	
207. Distance "G" (volant - paroi de séparation arrière) Distance "G" (steering wheel - rear bulkhead)			<u>890</u> mm		

### 3. MOTEUR/ENGINE

301. Emplacement et position du moteur  
Location and position of the engine

REAR CENTRAL LONGITUDINAL

302. Rapport volumétrique  
Volumetric ratio

11,96

303. Cycle  
Cycle

4 - STROKE OTTO

3A) Profil droit du moteur déposé  
Right-hand view of dismantled engine



3B) Profil droit du moteur déposé (vue supérieure)  
Right-hand view of dismantled engine (top view)



3C) Profil droit du moteur déposé (vue inférieure)  
Right-hand view of dismantled engine (lower view)



3D) Profil gauche du moteur déposé  
Left-hand view of dismantled engine



3E) Profil arrière du moteur déposé  
Rear view of dismantled engine



3F) Profil avant du moteur déposé  
Front view of dismantled engine





# W-RACING TEAM - FUN CUP

ANNEXE III - RÉVISION 04 (24-01-2024)

Pour les moteurs essence EVO 3



3G) Profil du moteur déposé (vue du dessus)  
View of dismantled engine (top view)

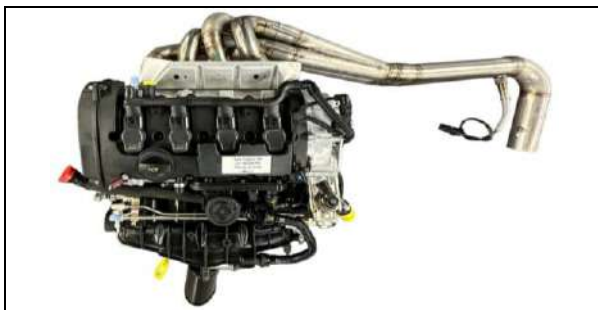

3H) Moteur dans son compartiment  
Engine in its compartment



3I) Câbles pour kit de sécurité (obligatoire)  
Cable for Safety Kit (mandatory)

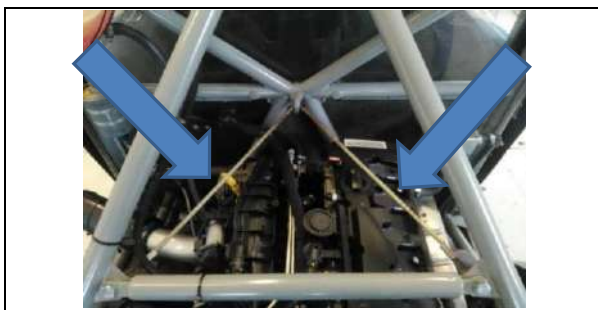

304. Suralimentation  
Supercharging

<input type="checkbox"/>	oui yes	<input checked="" type="checkbox"/>	non non
--------------------------	------------	-------------------------------------	------------

Type et nombre de compresseur(s)  
Type and number of compressor(s)

NA

305. Nombre et disposition des cylindres  
Number and layout of cylinders

4 - IN LINE

306. Mode de refroidissement  
Type of cooling

LIQUID



# W-RACING TEAM - FUN CUP

ANNEXE III - RÉVISION 04 (24-01-2024)

Pour les moteurs essence EVO 3



307. **Cylindrée**  
Cylinder capacity
- a) Unitaire  
Unitary **495,75** cm<sup>3</sup>
- b) Totale  
Total **1983** cm<sup>3</sup>
308. **Matériau du bloc-cylindres**  
Cylinder block materiel
- CAST IRON GJL 250**
309. **Chemises**  
Sleeves
- a)
- |                          |                                     |                          |
|--------------------------|-------------------------------------|--------------------------|
| <input type="checkbox"/> | <input checked="" type="checkbox"/> | <input type="checkbox"/> |
| oui                      | non                                 |                          |
| yes                      | non                                 |                          |
310. **Alésage**  
Bore
- 82,51** +/- 0.015 mm
311. **Course**  
Stroke
- 92,8** +/- 0.1 mm
312. **Piston**  
Piston
- a) Matériau  
Material **ALUMINIUM**
- b) Nombre de segments  
Number of rings **3**
- c) Poids piston avec axe et clips  
Piston weight with pin and clips **403,3 gr**
- d) Poids piston sans axe  
Weight piston without pin **339,5 gr**
- e) Référence piston **MO280**

3I) **Piston (vue 3/4 supérieur)**  
Piston (view 3/4 top)



3J) **Piston**  
Piston



3K) **Piston (vue latérale)**  
Piston (side view)



3L) **Piston (vue inférieure)**  
Piston (view under)





# W-RACING TEAM - FUN CUP

ANNEXE III - RÉVISION 04 (24-01-2024)

Pour les moteurs essence EVO 3



313. Bielle  
Connecting rods

- a) Matériau  
Material **CAST IRON**
- b) Type de la tête de bielle  
Big end type **SPLIT TWO PIECES**
- c) Diamètre intérieur de la tête de bielle (sans coussinets)  
Interior diameter of the big end (without shell bearings) **50,6** mm +/- 0.01 mm
- d) Longueur entre axes  
Length between the axes **144** +/- 0.01 mm
- e) Poids  
Weight **0,51 kg**
- f) Référence kit 4 bielles  
**MO302**

3M) Bielle  
Connecting rods



3N) Bielle  
Connecting rods



314. Vilebrequin  
Crankshaft

- a) Type de construction  
Type of manufacture **SINGLE PIECE**
- b) Matériau  
Material **STEEL TL 1438**
- c) 

X	coulé cast		forgé forged
---	---------------	--	-----------------
- d) Nombre de paliers  
Number of bearings **5**
- e) Poids minimum du vilebrequin nu  
Minimum weight of bare crankshaft **14759 gr**
- f) Diamètre des paliers  
Diameter of bearings **54** mm +/- 0.01 mm
- g) Poids minimum du vilebrequin avec la cible  
Minimum crankshaft weight with target **15230 gr**

3O) Vilebrequin  
Crankshaft

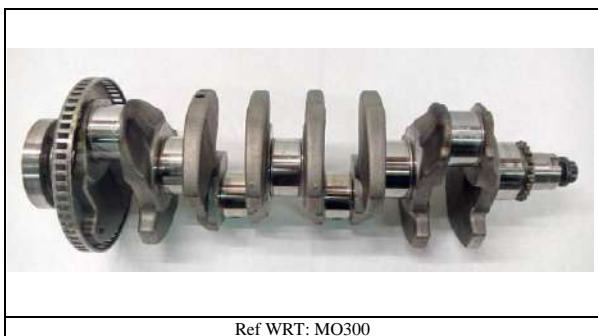

3P) Vilebrequin  
Crankshaft





# W-RACING TEAM - FUN CUP

ANNEXE III - RÉVISION 04 (24-01-2024)

Pour les moteurs essence EVO 3



**315. Volant moteur**  
Flywheel

- a) Matériau  
Material
- b) Poids minimum avec couronne de démarreur  
Minimum weight with starter ring
- c) Épaisseur  
Thickness

Boîte manuelle/Manual gearbox	boîte automatique/Automatic gearbox
<b><u>STEEL</u></b>	
<b><u>5,9 kg +/- 100 g</u></b>	<b><u>NA</u></b>
<b><u>21,3 mm</u></b>	

**3Q) Volant moteur**  
Flywheel



**3R) Volant moteur**  
Flywheel

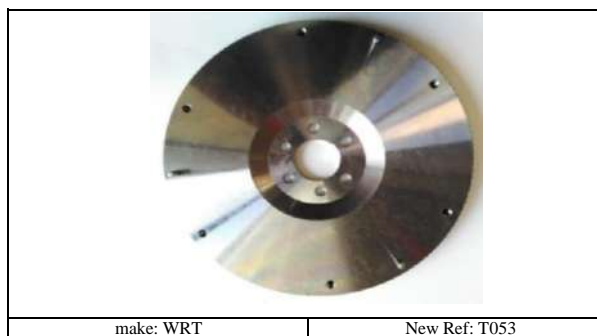

**3S) Volant moteur**  
Flywheel

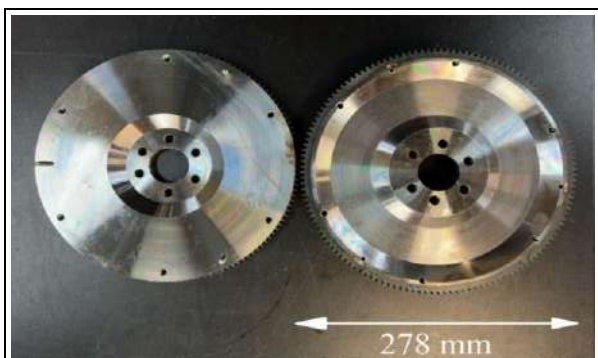



# W-RACING TEAM - FUN CUP

ANNEXE III - RÉVISION 04 (24-01-2024)

Pour les moteurs essence EVO 3



316. Culasse  
Cylinder head
- a) Nombre  
Number **1**
- b) Matériau  
Material **Aluminium alloy AISI10Mg**
- c) Angle entre soupapes admission et la verticale  
Angle between intake valve and vertical **23°24'**
- d) Angle entre soupapes d'échappement et la verticale  
Angle between exhaust valve and vertical **21°30'**
- e) Référence culasse  
Cylinder head reference **M005W**

- 3T) Culasse  
Cylinder head
- 3U) Chambre de combustion  
Combustion chamber

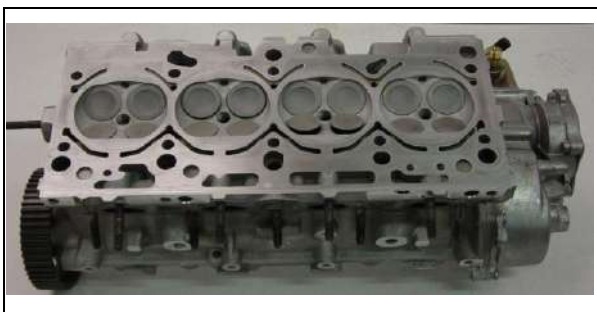

- 3V) Voilet dans la culasse  
Flap in the cylinder head

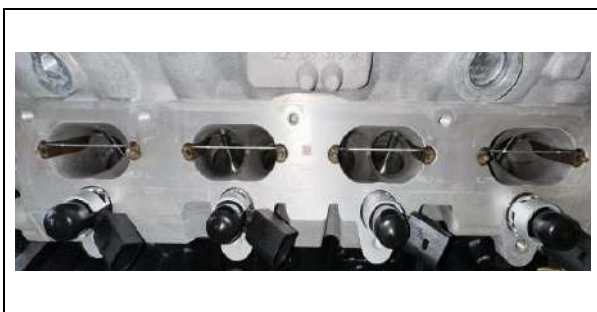

317. Épaisseur du joint de culasse  
Thickness of cylinder head gasket

- a) Épaisseur  
Thickness **0,9 mm compressé**

- 3W) Joint de culasse  
Cylinder head gasket



Ref WRT: MO262



# W-RACING TEAM - FUN CUP

ANNEXE III - RÉVISION 04 (24-01-2024)

Pour les moteurs essence EVO 3



## 318. Alimentation par injection Fuel feed by injection

- a) Marque  
Make **VW**
- b) Modèle  
Model **06F 906**
- c) Mode de dosage du carburant  
Dimensions of the intake pipe at the throttle or slide location
- |                          |                         |                                     |                            |                          |                          |
|--------------------------|-------------------------|-------------------------------------|----------------------------|--------------------------|--------------------------|
| <input type="checkbox"/> | mécanique<br>mechanical | <input checked="" type="checkbox"/> | électronique<br>electronic | <input type="checkbox"/> | hydraulique<br>hydraulic |
|--------------------------|-------------------------|-------------------------------------|----------------------------|--------------------------|--------------------------|
- d) Dimension du conduit d'admission au niveau du papillon ou de la guillotine  
Dimensions of the intake pipe at the throttle or slide location **57** +/- 0.25 mm
- e) Nombre de sorties effectives de carburant  
Number of effective fuel outlets **4**
- f) Position des injecteurs  
Position of injectors
- |                          |                        |                                     |                          |
|--------------------------|------------------------|-------------------------------------|--------------------------|
| <input type="checkbox"/> | Collecteur<br>manifold | <input checked="" type="checkbox"/> | culasse<br>cylinder head |
|--------------------------|------------------------|-------------------------------------|--------------------------|
- g) Capteur du système d'injection  
Sensors of injection system **SEE NEXT PAGES**

## 3X) Injecteur Injector



make: VW	Ref: 06F 906 036 F
	Ref WRT: MO286



### LOCALISATION DES CAPTEURS ET ACTIONNEURS/LOCATION OF SENSORS AND ACTUATORS

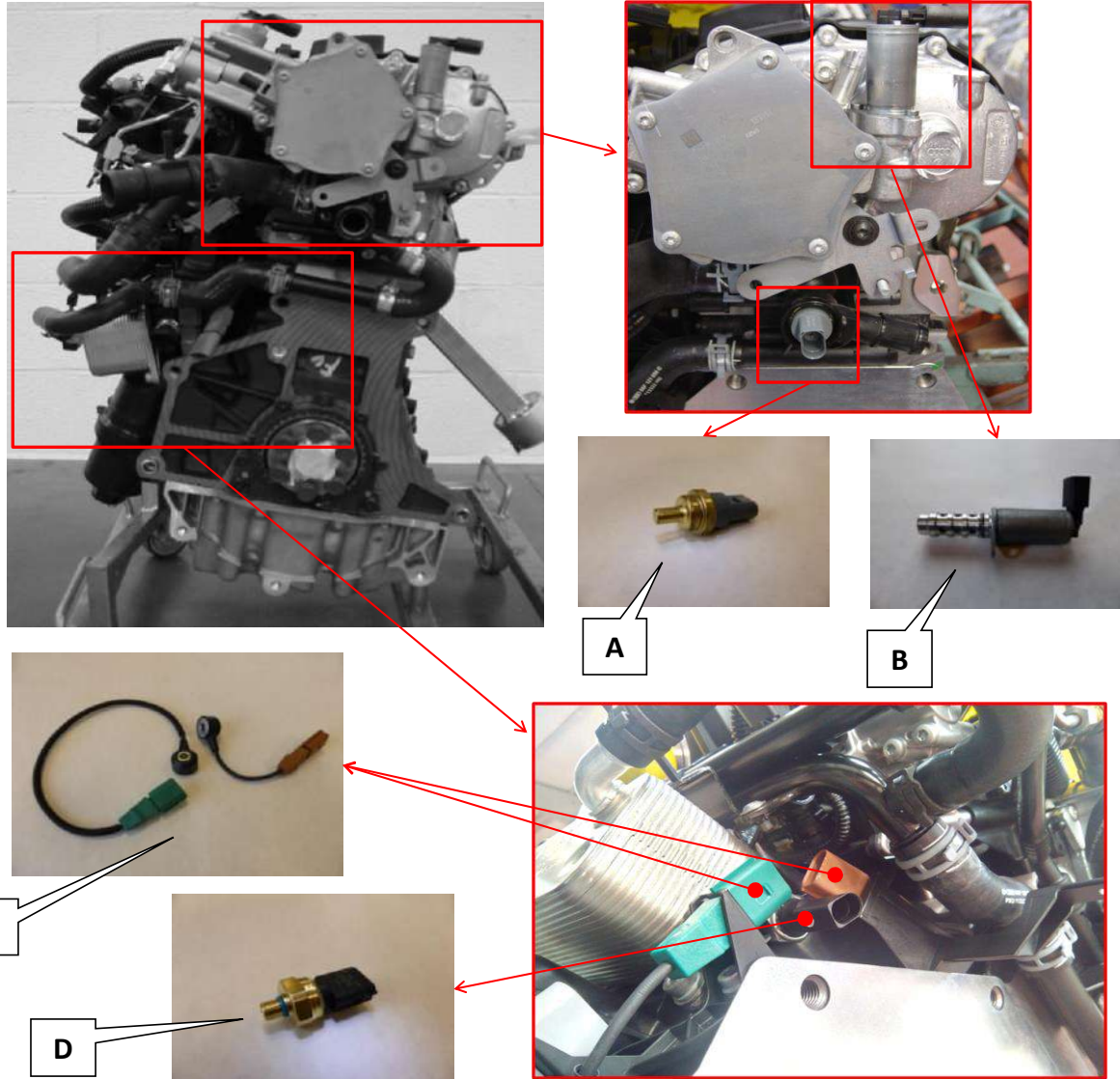

**A. Engine coolant temperature sensor**

make: VW / ref: 06A 919 501 A  
Ref WRT: MO205

**B. Cam control valve**

make: VW / ref: 06F 109 257 C  
Ref WRT: MO264A

**C. Knock sensors**

make: VW / ref: 06E 905 377 A + 06 F 905 377  
Ref WRT: MO249 (vert) & MO206 (brun)

**D. Engine oil pressure sensor**

make: VW / ref: 06E 906 051 K  
Ref WRT: MO253

### LOCALISATION DES CAPTEURS ET ACTIONNEURS/LOCATION OF SENSORS AND ACTUATORS

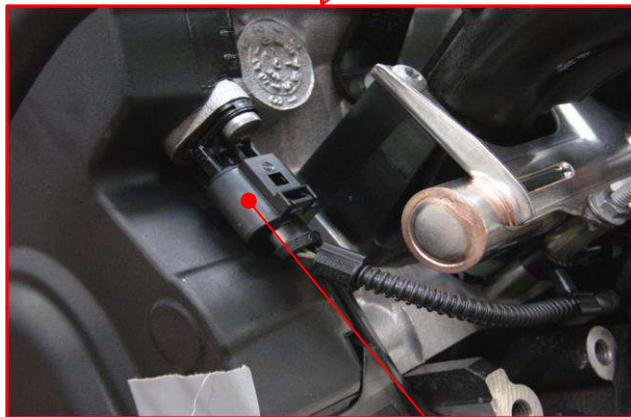
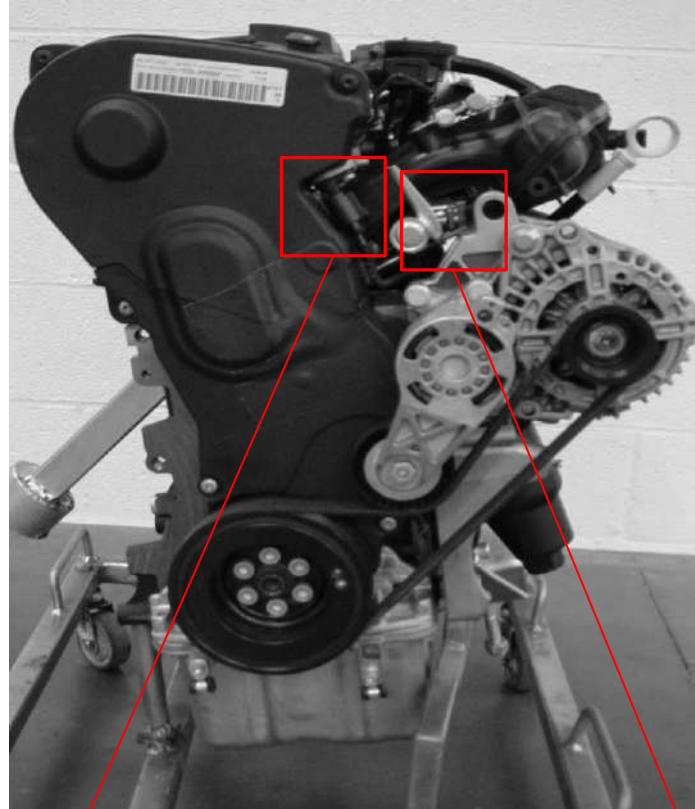

**E**



**E. Camshaft position sensor**  
make: VW / ref: 06C 905 163 B  
Ref WRT: MO250

**F**



**F. Fuel pressure sensor**  
make: VW / ref: 06J 906 051 D  
Ref WRT: MO255

### LOCALISATION DES CAPTEURS ET ACTIONNEURS/LOCATION OF SENSORS AND ACTUATORS



G

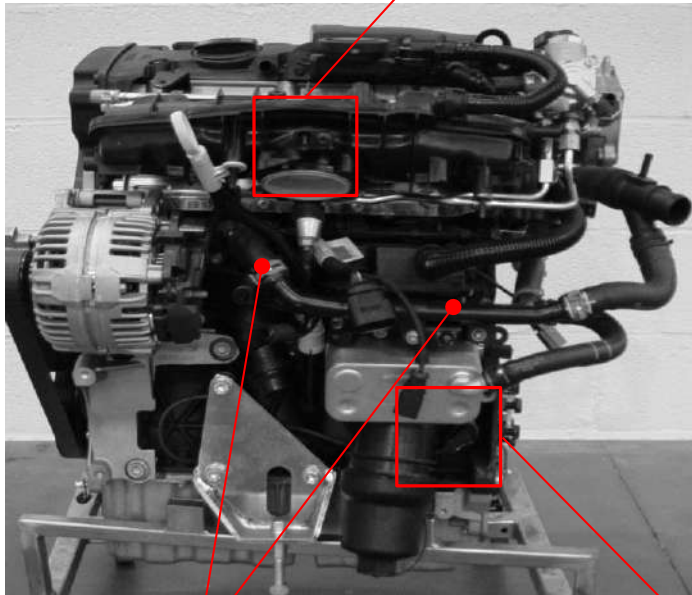
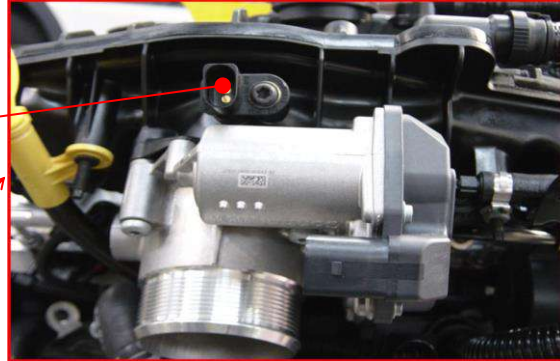

C



H

**G. Air temperature sensor**  
make: VW / ref: 06B 905 379D  
Ref WRT: MO246

**H. Crankshaft position sensor**  
make: VW / ref: 037 906 433 A  
Ref WRT: MO234

### LOCALISATION DES CAPTEURS ET ACTIONNEURS/LOCATION OF SENSORS AND ACTUATORS

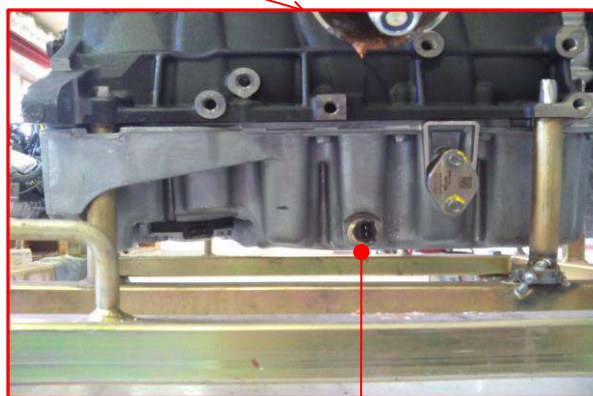
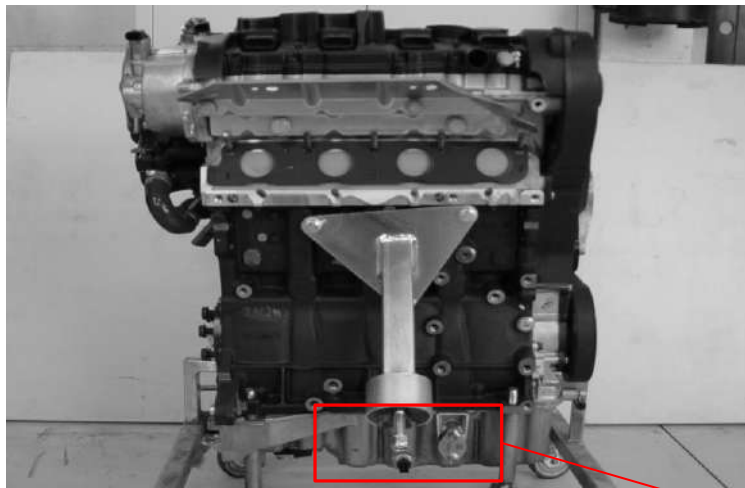

I

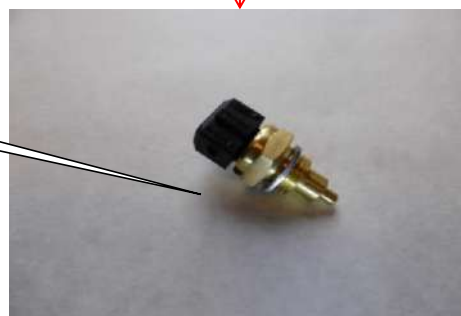

**I. Engine oil temperature sensor**  
Ref WRT: MO251

## LOCALISATION DES CAPTEURS ET ACTIONNEURS/LOCATION OF SENSORS AND ACTUATORS



J

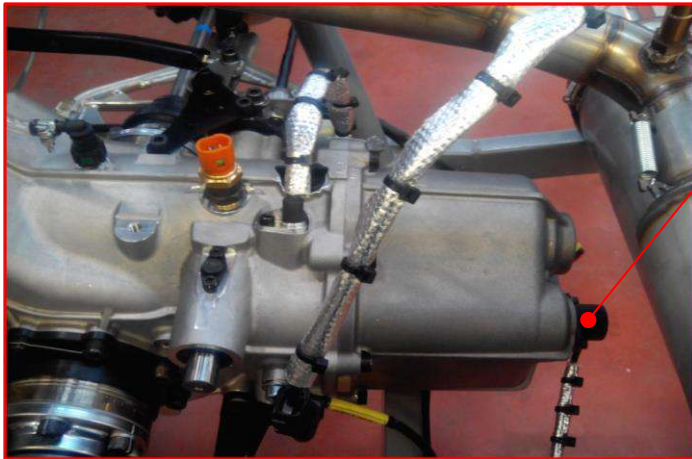

K

- J. Lambda probe**  
make: VW / ref: 06J 906 262 AA  
Ref WRT: MO231
- K. Gear ratio indicators**  
Ref WRT: BS028

### LOCALISATION DES CAPTEURS ET ACTIONNEURS/LOCATION OF SENSORS AND ACTUATORS

L. ENGINE MANAGEMENT SYSTEM (type 1): BOSCH MS 4 SPORTS (COCKPIT)



M. INJECTION POWER STAGE: BOSCH HPI 5 (COCKPIT)



N. ENGINE MANAGEMENT SYSTEM 2 (type 2)



Ref WRT: M011K

O. DATA ACQUISITION SYSTEM: AIM MXL STRADA (COCKPIT) - OPTION



Ref.: E040

### LOCALISATION DES CAPTEURS ET ACTIONNEURS/LOCATION OF SENSORS AND ACTUATORS

#### P. DATA ACQUISITION SYSTEM: AIM MXS (COCKPIT) - OPTION



Ref.: E042

#### Q. DATA ACQUISITION SYSTEM: AIM MXG (COCKPIT) - OPTION



Ref.: E041

#### R. DATA ACQUISITION SYSTEM: AIM MXP (COCKPIT) - OPTION



Ref.: E052

### LOCALISATION DES CAPTEURS ET ACTIONNEURS/LOCATION OF SENSORS AND ACTUATORS

#### S. DATA ACQUISITION SYSTEM: AIM MXL2 (COCKPIT) - OPTION



Ref.: E040

#### T. DATA ACQUISITION SYSTEM: AIM MXM (COCKPIT) - OPTION

Ref.: E053



#### U. CRISARTECH TB100



#### V. PÉDALE D'ACCÉLÉRATEUR / THROTTLE PEDAL



Ref.: M047





# W-RACING TEAM - FUN CUP

ANNEXE III - RÉVISION 04 (24-01-2024)

Pour les moteurs essence EVO 3



<b>319. Arbre à cames</b> <b>Camshaft</b>	a) Nombre Number	<u>2</u>	b) Emplacement Location	<u>CYLINDER HEAD</u>	
	c) Système d'entraînement Drive system	<u>BELT AND CHAIN</u>	d) Nombre de paliers par arbre Number of bearings per shaft	<u>6</u>	
	e) Diamètres des paliers Diameters of bearing	<u>23,95</u> +/- 0.2 mm	f) Dimensions de la came Cam dimensions		
	g) Levée des soupapes Valve lift	Admission Intake	<u>6,4</u> mm +/- 0.1 mm	Admission Intake	<u>A = 31,94</u> +/- 0.05 mm <u>B = 38,35</u> +/- 0.05 mm
		Échappement Exhaust	<u>6,03</u> mm +/- 0.1 mm	Échappement Exhaust	<u>A = 32,01</u> +/- 0.05 mm <u>B = 38,01</u> +/- 0.05 mm

3Y) Arbres à cames  
Camshafts

3Z) Came - dessin  
Shaft - drawing



Ref WRT AaC ADM: MO391

Ref WRT AaC ECH: MO392

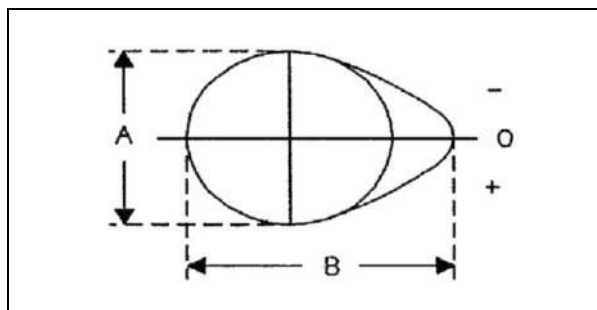

3AA) Culbuteur  
Rocker arms

3AB) Variateur d'arbre à cames  
Camshaft variator



Ref WRT culbuteur : MO373



Ref WRT variateur : MO264A

<b>320. Admission</b> <b>Intake</b>	a) Matériau du collecteur Material of manifold	<b><u>PLASTIC</u></b>	b) Nombre d'éléments du collecteur Number of manifold elements	<b><u>1</u></b>
	c) Nombre de soupapes par cylindre Number of valves per cylinder	<b><u>2</u></b>	d) Diamètre maximum de soupape Maximum diameter of the valve	<b><u>33.85</u></b> mm
	e) Diamètre de tige de soupape dans guide Diameter of the valve stem in guide	<b><u>6</u></b> +/- 0.2 mm	f) Longueur de soupape Valve length	<b><u>104</u></b> +/- 1.5 mm

3AC) Collecteur d'admission  
Intake manifold

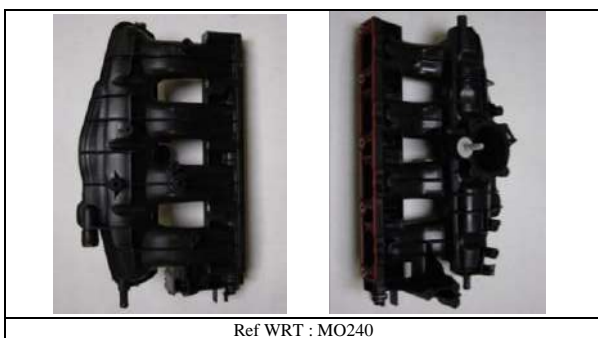

3AD) Volet dans le collecteur d'admission  
Flap in the intake manifold

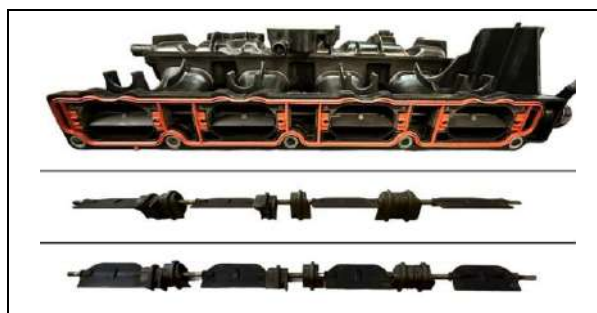

3AE) Boîtier filtre à air  
Airbox



3AF) Filtre à air  
Air Filter



3AG) Système de récupération des gaz carter  
Crankcase gas recovery system



3AH) Système de récupération des gaz carter  
Crankcase gas recovery system



**321. Boîtier papillon**  
Throttle valve housing

3AI) Boîtier papillon  
Throttle valve housing



Ref WRT: M014

3AJ) Boîtier papillon  
Throttle valve housing



3AK) Boîtier papillon  
Throttle valve housing



3AL) Boîtier papillon  
Throttle valve housing



**322. Échappement**  
Exhaust

a) Matériau du collecteur  
Material of manifold

**STEEL**

b) Nombre d'éléments du collecteur  
Number of manifold elements

**1**

c) Nombre de soupapes par cylindre  
Number of valves per cylinder

**2**

d) Diamètre maximum de soupape  
Maximum diameter of the valve

**28** mm

e) Diamètre de tige de soupape dans guide  
Diameter of the valve stem in guide

**6** +/- 0,2 mm

f) Longueur de soupape  
Valve length

**102** +/- 1.5 mm

3AM) Collecteur d'échappement - ancien modèle (plus valable à partir de 2025)  
Exhaust manifold - old model (will not be valid anymore from 2025)



make: WRT

Ref without coupling sleeve: M051

3AN) Collecteur d'échappement - nouveau modèle  
Exhaust manifold - new model



make: WRT

Ref without coupling sleeve: M051



# W-RACING TEAM - FUN CUP

ANNEXE III - RÉVISION 04 (24-01-2024)

Pour les moteurs essence EVO 3



3AO) Pot d'échappement  
Exhaust muffler



make: WRT

Ref: M056 (part 1)

3AP) Nouvelle sortie d'échappement  
New exhaust and pipe



make: WRT

Ref: M058

3AQ) Silencieux additionnel  
Additional muffler



make: WRT

Ref: M059

323. Système d'allumage  
Ignition system

a) Nombre de bougies par cylindre  
Number of plugs per cylinder

**1**

b) Nombre de distributeurs  
Number of distributors

**NA**

3AR) Bougie d'allumage (Bosch et Beru)  
Spark plugs (Bosh and Beru)



make: WRT

Ref: M239

3AS) Bobine d'allumage (Bosch et Beru)  
Spark coils (Bosh and Beru)



make: WRT

Ref: M224



# W-RACING TEAM - FUN CUP

ANNEXE III - RÉVISION 04 (24-01-2024)

Pour les moteurs essence EVO 3



## 324. Radiateur d'eau moteur Engine water radiator

- a) Marque  
make

**WRT**

## 3AT) Radiateur d'eau moteur dans son emplacement Engine water radiator in its location



## 3AU) Radiateur d'eau moteur dans son emplacement Engine water radiator in its location



make: WRT

New Ref: M094

## 3AV) Modèle de radiateur avec purgeur Engine water radiator with bleeder



## 3AW) Plans radiateur Engine water radiator drawings

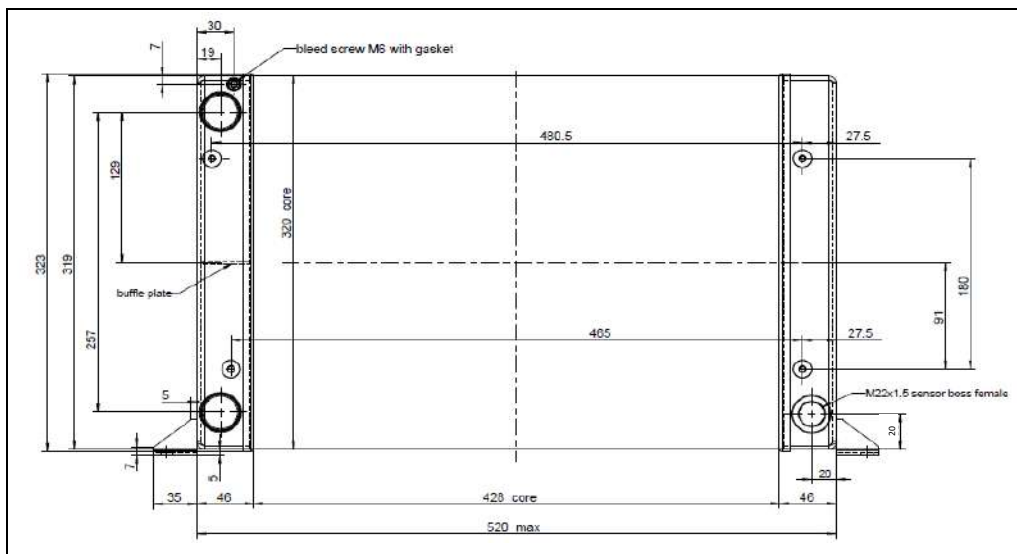



# W-RACING TEAM - FUN CUP

ANNEXE III - RÉVISION 04 (24-01-2024)

Pour les moteurs essence EVO 3



- 3AX) Plans radiateur  
Engine water radiator drawings

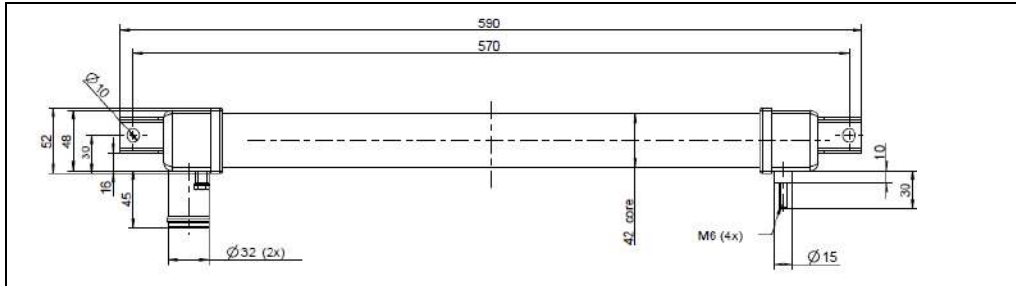

325. Refroidissement d'eau  
Water cooling

- 3AY) Thermostat  
Thermostat



326. Système de lubrification  
Lubrication System

- a) Type  
Type

**WET SUMP**

- b) Nombre de pompe à huile  
Number of oil pump

**1**

- 3AZ) Pompe à huile dans le carter avec arbre d'équilibrage  
Oil pump in crankcase with balance shaft

- 3BA) Pompe à huile dans le carter avec arbre d'équilibrage  
Oil pump in crankcase with balance shaft



Ref WRT: MO341





# W-RACING TEAM - FUN CUP

ANNEXE III - RÉVISION 04 (24-01-2024)

Pour les moteurs essence EVO 3



**327. Support moteur**  
Engine mount

3BB) Support moteur gauche  
Left engine mounts

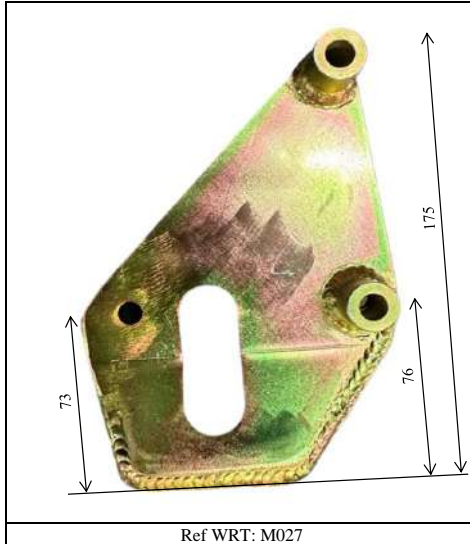

Support moteur droit  
Right engine mounts

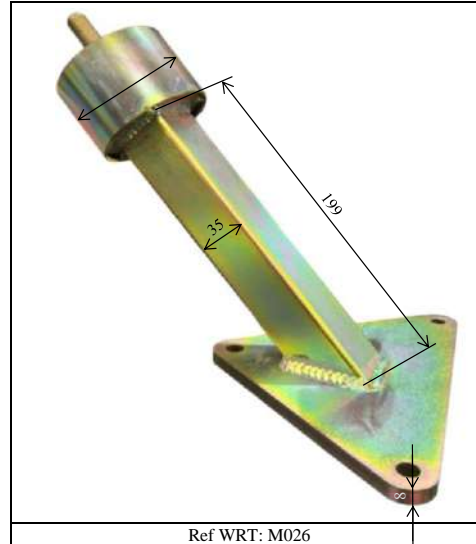

### 4. CIRCUIT DE CARBURANT/FUEL CIRCUIT

#### 401. Réservoir et accessoires Fuel tank and accessories

a) Nombre  
Number

**1**

b) Emplacement  
Location

**FRONT COMPARTMENT**

c) Matériau  
Material

**FT3**

d) Capacité totale  
Total capacity

**44 L**

4A) Réservoir de carburant dans son emplacement  
Fuel tank in its location



4B) Pompe à essence démontée  
Dismounted Fuel pump

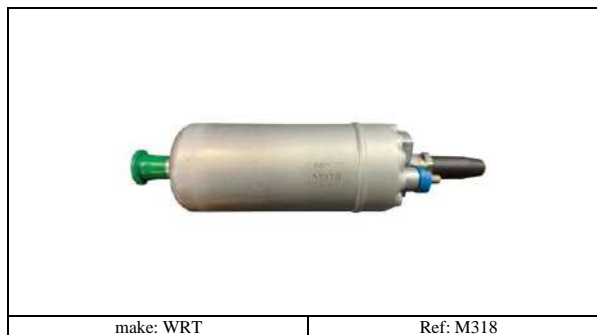

4C) Pompe à essence montée (sous le réservoir)  
Mounted fuel pump (under the fuel tank)



4D) Détail du tuyau de mise à l'air libre  
Detail of fuel tank breather



4E) Filtre à essence  
Petrol Filter



4F) Préfiltre à essence version 1 (plus valable à partir de 2025)  
Fuel pre-filter version 1 (no longer valid from 2025)

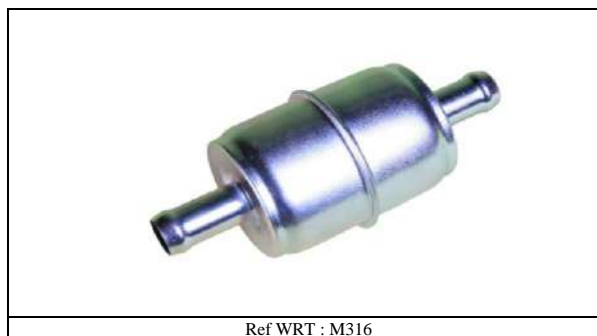



- 4G) Préfiltre à essence version 2 (montage obligatoire à partir de 2025)  
Fuel pre-filter version 2 (mandatory from 2025)



Ref WRT : M317A

- 4H) Kit de préfiltre à essence version 2 (montage obligatoire à partir de 2025)  
Fuel pre-filter kit version 2 (mandatory from 2025)



Ref WRT : M317

- 4I) Bac réservoir  
Tank container



Ref WRT : M113

- 4J) Bac réservoir  
Tank container



- 4K) Plan du bac réservoir  
Plan of the tank

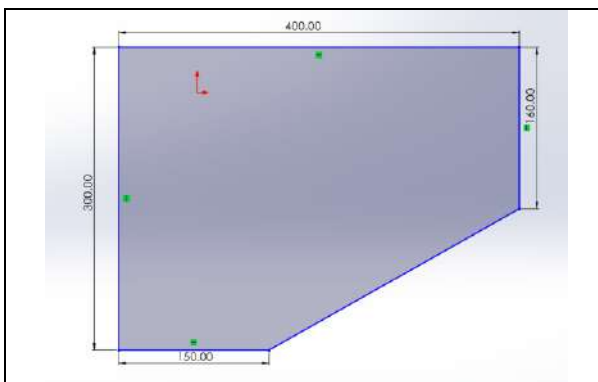

- 4L) Plan du bac réservoir  
Plan of the tank

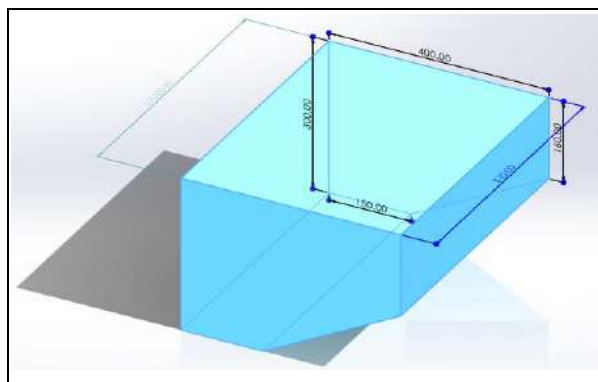

- 4M) Pompe haute pression avec axe  
High-pressure pump with shaft



**L'axe de la pompe haute pression a un diamètre de 8 mm**

**The high-pressure pump shaft has a diameter of 8 mm**

### 5. ÉQUIPEMENT ÉLECTRIQUE/ELECTRICAL EQUIPMENT

#### 501. Batterie Battery

- a) Nombre  
Number **1**
- b) Tension  
Tension **12** Volts
- c) Emplacement  
Location **FRONT COMPARTMENT OR COCKPIT**

#### d) Batteries autorisées Allowed batteries

Capacity	Dimensions	Make (type)
<b><u>42 A/h - CCA 330 A</u></b>	<b><u>185x125x200</u></b>	<b><u>ROCKET</u></b>
<b><u>62 A/h - CCA 520 A</u></b>	<b><u>240x175x190</u></b>	<b><u>EUROSTART extra power</u></b>
<b><u>34 A/h - CCA 950 A</u></b>	<b><u>250x97x152</u></b>	<b><u>ODYSSEY (extreme racing 30)</u></b>
<b><u>45 A/h - CCA 1100 A</u></b>	<b><u>250x97x204</u></b>	<b><u>ODYSSEY (extreme racing 40)</u></b>

#### 502. Alternateur Alternator

- a) Marque  
Make **BOSCH**
- b) Références  
References **06F 903023G**
- c) Poids alternateur  
Alternator weight **5,7 kg** +/- 100 gr
- d) Poids poulie damper  
Damper pulley weight **1,65 kg** +/- 100 gr

#### 5A) Alternateur déposé Dismounted alternator



#### 5B) Alternateur monté dans son emplacement Alternator - mounted in its location



#### 5C) Alternateur déposé Dismounted alternator



#### 5D) Alternateur déposé Dismounted alternator



5E) Alternateur déposé  
Dismounted alternator



5F) Alternateur déposé  
Dismounted alternator



503. Poulie damper  
Damper pulley

5G) Poulie Damper  
Damper Pulley



5H) Poulie Damper  
Damper Pulley



5I) Poulie Damper  
Damper Pulley





# W-RACING TEAM - FUN CUP

ANNEXE III - RÉVISION 04 (24-01-2024)

Pour les moteurs essence EVO 3



## 504. Démarreur Starter

- a) Position  
Position

**ENGINE COMPARTMENT - UNDER RIGHT**

## 5J) Démarreur déposé Dismounted starter



## 504. Composants électriques Electrical components

## 5K) Feux avant Front lights

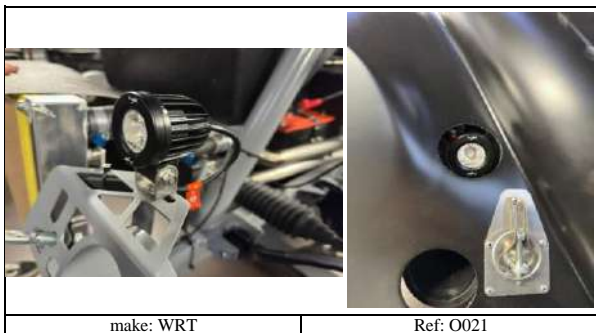

## 5L) Feu Anti-Crash LED LED Rain Light

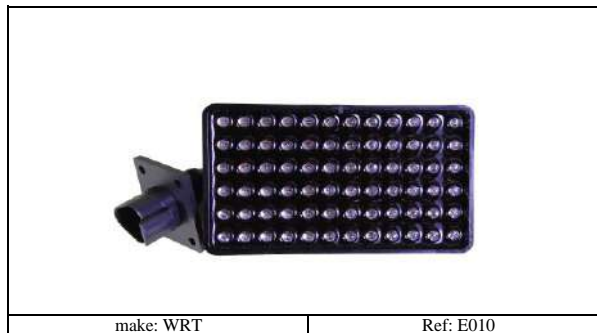

## 5M) Feu Anti-Crash LED monté Mounted LED Rain Light

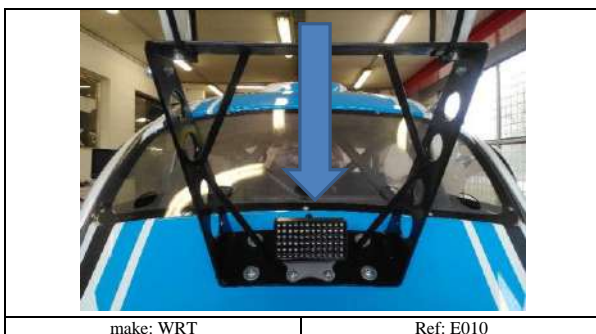

## 5N) Support de feu LED arrière bleu (uniquement pour biplace avec passager) Support for rear blue led light (only for two-seater with a passenger)



- 50) Feu LED arrière bleu (uniquement pour biplace avec un passager)  
Rear blue led light (only for two-seater with a passenger)

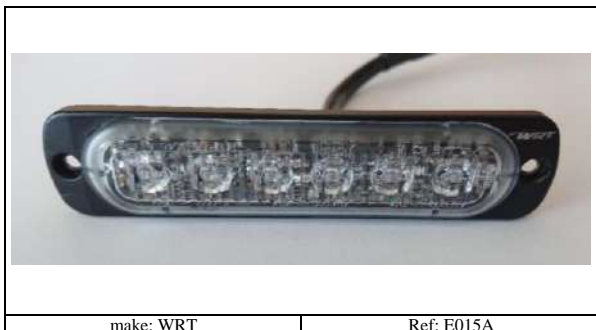

- 5P) Kit feu LED arrière bleu monté (uniquement pour biplace)  
Mounted rear blue led light kit (only for two-seater with a passenger)

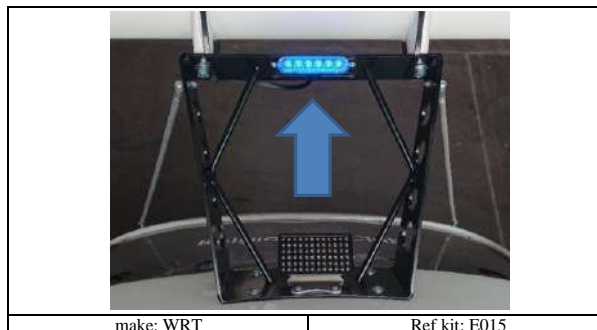

505. **Rampe de phares**  
**Headlamp ramp**

- 5Q) Rampe de phares montée  
Headlamp ramp mounted

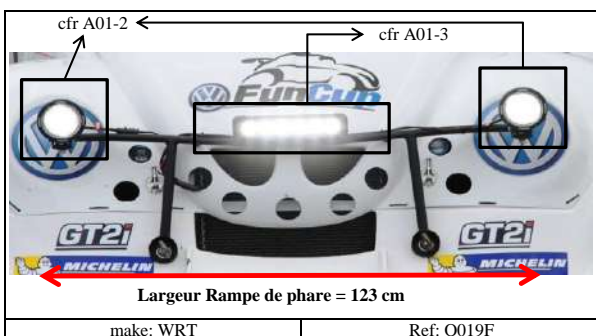

- 5R) Phares latéraux  
Side headlamp



- 5S) Barre de phares centrale (6 x 10W)  
Central lightbar (6 x 10W)





# W-RACING TEAM - FUN CUP

ANNEXE III - RÉVISION 04 (24-01-2024)

Pour les moteurs essence EVO 3



## 6. TRANSMISSION/POWER TRAIN

### 601. Roues motrices

Driven wheels

**REAR**

### 602. Embrayage

Clutch

a) Type

Type

**DRY**

b) Système de commande

Control system

**HYDRAULIC/PUSHED**

c) Nombre de disques

Number of plates

**1**

d) Diamètre du disque

Diameter of the plate

**228** +/- 2 mm

e) Poids du groupe de pression

Pressure unit weight

**4,56 kg** +/- 100 gr

f) Poids du disque d'embrayage

Clutch disc weight

**1,73 kg** +/- 100 gr

#### 6A) Groupe de pression démonté sans disque

Pressure unit dismantled without disc

#### 6B) Groupe de pression démonté sans disque

Pressure unit dismantled without disc



make: ZF ZACHS RACE

Old Ref: MF 210X/MF228

New Ref: T057



make: ZF ZACHS RACE

Old Ref: MF 210X/MF228

New Ref: T057

#### 6C) Disque d'embrayage

Clutch disc

#### 6D) Disque d'embrayage

Clutch disc



make: ZF ZACHS RACE

Old Ref: 228 TC

New Ref: T056



make: ZF ZACHS RACE

Old Ref: 228 TC

New Ref: T056

#### 6E) Butée d'embrayage

Clutch bearing

#### 6F) Cylindre émetteur d'embrayage (diam 25,4 mm conseillé - 22,2mm autorisé)

Clutch master cylinder (diameter 25,4 mm recommended - 22,2mm allowed)



make: AP RACING

Ref: CP 6859-54

Ref WRT : T006S



Ref WRT

T017



# W-RACING TEAM - FUN CUP

ANNEXE III - RÉVISION 04 (24-01-2024)

Pour les moteurs essence EVO 3



## 603. Boîte de vitesse Gearbox

a) Emplacement  
Location

**ARRIÈRE LONGITUDINAL**

b) Marque  
Make

**SADEV SL82-14**

d) Type et emplacement de commande  
Type and location of control

**MECHANICAL IN COCKPIT**

e) Rappports  
Ratios

	MONOPLACE ONLY				
	nombre de dents of teeth	number	rapport ratio	constant	synchro
M	1	<b>11 X 32</b>	<b>2,909:1</b>		
O	2	<b>15 X 30</b>	<b>2:1</b>		
N	3	<b>18 X 27</b>	<b>1,5:1</b>		
O	4	<b>22 X 26</b>	<b>1.182 : 1</b>		
OR	5	<b>28 X 27</b>	<b>0,964:1</b>		
B	6	<b>X</b>	<b>X</b>		
I	R	<b>15 X 46</b>	<b>3,067 : 1</b>		
P	Constante constant				
L					
A					
C					
E					

f) Grille de vitesse  
Gear change gate



g) Type de lubrification  
Type of lubrication

**SPLASH**

h) Refroidisseur(s) d'huile de boîte  
Gearbox oil cooler(s)

<input type="checkbox"/>	oui yes	<input type="checkbox"/>	non non	<input checked="" type="checkbox"/>	Option Option
--------------------------	------------	--------------------------	------------	-------------------------------------	------------------

## 604. Refroidissement boîte de vitesse Gear box cooling

6G) Système de refroidissement complet démonté  
Complete cooling system dismantled

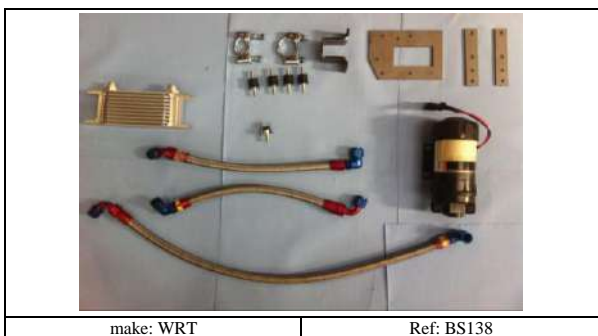

make: WRT

Ref: BS138

6H) Radiateur  
Radiator



Ref WRT: T066



# W-RACING TEAM - FUN CUP

ANNEXE III - RÉVISION 04 (24-01-2024)

Pour les moteurs essence EVO 3



6I) Pompe  
Pump



Ref WRT: T065

6J) Système de refroidissement complet monté  
Complete cooling system mounted

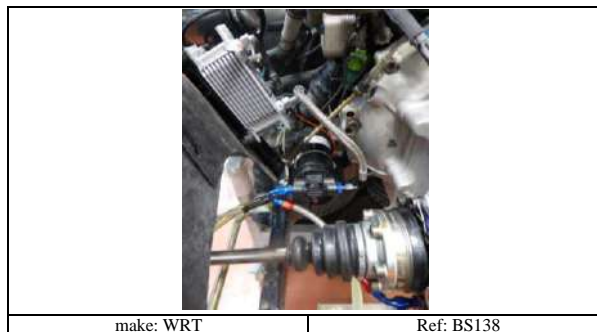

make: WRT

Ref: BS138

605. Changement de vitesse au volant  
Paddle shift

6K) Système complet démonté  
Complete system dismantled

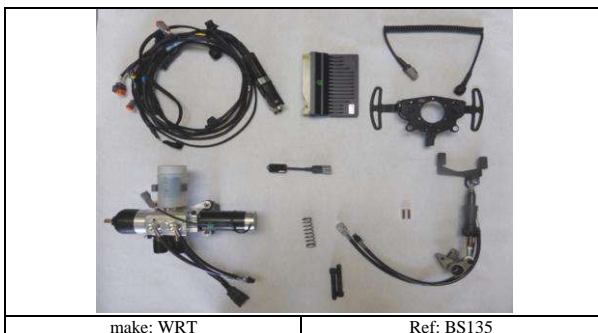

make: WRT

Ref: BS135

6L) Palettes au volant  
Paddle shift



Ref WRT: BS135G (palette pour volant 1 bouton)

6M) Groupe hydraulique paddle shift et réservoir montés  
Hydraulic paddle shift unit and tank mounted

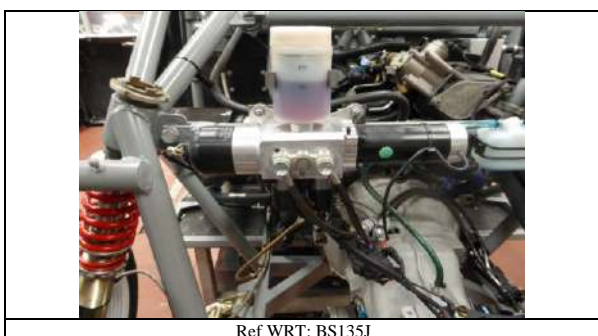

Ref WRT: BS135J

6N) Vérin monté  
Cylinder mounted



Ref WRT: BS135A

6O) Boîtier paddle shift monté  
ECU paddle shift mounted

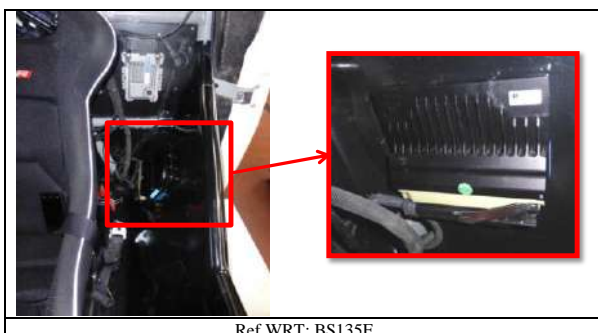

Ref WRT: BS135F



**606. Changement de vitesse avec stick**  
Gear change with lever

6P) Levier de vitesse  
Gearlever



Ref WRT : BS030

**607. Couple final**  
Final drive

a) Type de couple final  
Type of final drive

**BEVEL DRIVE PINIONS**

b) Rapport  
Ratio

**3,875**

c) Nombre de dents  
Number of teeth

**31/8**

d) Type de limitation de différentiel  
Type of differential

**FREE DIFFERENTIAL**

e) Marque du différentiel  
Make of central differential

**SADEV**

f) Type de lubrification  
Type of lubrication

**SPLASH**

6Q) Carter de boîte de vitesse et embrayage  
Gearbox casing and clutch bell housing



6R) Carter de boîte de vitesse et embrayage  
Gearbox casing and clutch bell housing



6S) Carter de boîte de vitesse et embrayage  
Gearbox casing and clutch bell housing



6T) Carter de boîte de vitesse et embrayage  
Gearbox casing and clutch bell housing



- 6U) Différentiel - vue éclatée  
Differential - exploded view

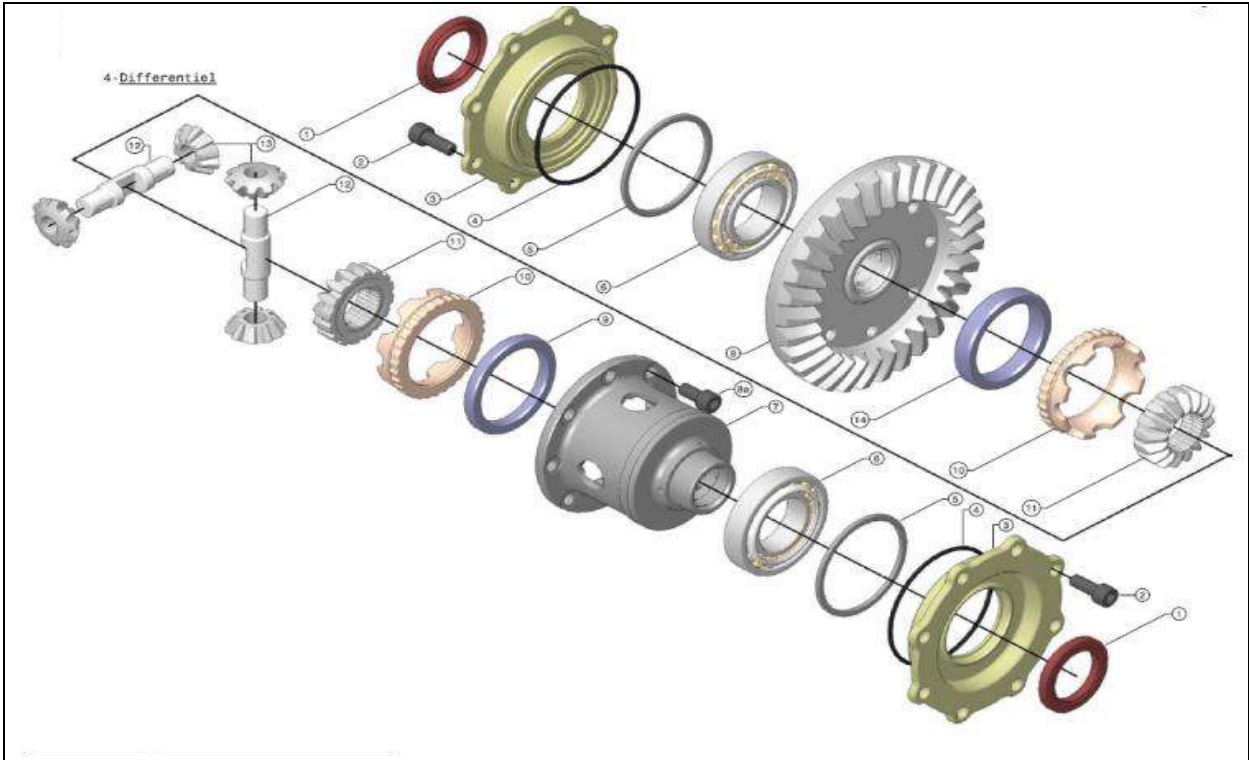



# W-RACING TEAM - FUN CUP

ANNEXE III - RÉVISION 04 (24-01-2024)

Pour les moteurs essence EVO 3



## 608. Arbres de transmission Transmission shaft

- |  |                  |  |                          |
|--|------------------|--|--------------------------|
| a) Type des arbres transversaux et joints<br>Type of transversal shafts and joints               | <b>UNIVERSAL</b> | b) Matériau des arbres transversaux<br>Material of transversal shafts            | <b>STEEL</b>             |
| c) Diamètre et épaisseur des arbres transversaux<br>Diameter and thickness of transversal shafts | <b>21,6 mm</b>   | d) Poids minimum des arbres transversaux<br>Minimum weight of transversal shafts | <b>5,7 kg</b> +/- 100 gr |

### 6U) Arbre transversal gauche déposé Dismounted transversal link shaft



### 6V) Arbre transversal droit déposé Dismounted transversal right shaft



### 6W) Détail côté boîte Detail gearbox side



### 6X) Détail côté moyeu Detail hubs side



### 6Y) Tête de l'arbre de transmission (côté boîte et moyeu) Transmission shaft head (gearbox and hub side)



### 6F) Bague de cardan Cardan Ring





# W-RACING TEAM - FUN CUP

ANNEXE III - RÉVISION 04 (24-01-2024)

Pour les moteurs essence EVO 3



## 7. SUSPENSION/SUSPENSION

### 701. Généralités General

- a) Type de suspension  
Type of suspension

	AVANT/FRONT				ARRIÈRE/REAR			
	<b><u>McPHERSON</u></b>				<b><u>McPHERSON</u></b>			
702. Ressorts hélicoïdaux Helicoidal springs	<input checked="" type="checkbox"/>	oui yes	<input type="checkbox"/>	non non	<input checked="" type="checkbox"/>	oui yes	<input type="checkbox"/>	non non
703. Ressorts à lames Leaf springs	<input type="checkbox"/>	oui yes	<input checked="" type="checkbox"/>	non non	<input type="checkbox"/>	oui yes	<input checked="" type="checkbox"/>	non non
704. Barres de torsion Torsion bars	<input type="checkbox"/>	oui yes	<input checked="" type="checkbox"/>	non non	<input type="checkbox"/>	oui yes	<input checked="" type="checkbox"/>	non non

### 705. Autre type de suspension Other type of suspension

**NA**

### 706. Amortisseur Shock absorbers

- a) Nombre par roue  
Number per wheel
- b) Type  
Type
- c) Principe de fonctionnement  
Principle of operation

	AVANT/FRONT		ARRIÈRE/REAR	
a)	<b><u>1</u></b>		<b><u>1</u></b>	
b)	<b><u>TELESCOPIC</u></b>		<b><u>TELESCOPIC</u></b>	
c)	<b><u>HYDRAULIC</u></b>		<b><u>HYDRAULIC</u></b>	

### 707. Type de ressorts Type of springs

- a) Type de ressort  
Type of spring
- b) Matériau  
Material
- c) Diamètre de fil  
Diameter of wire
- d) Diamètre extérieur  
External diameter
- e) Nombre de spires  
Number of coils
- f) Longueur libre maximale  
Maximum free length
- g) Rigidité  
Stiffness

	SET 1	SET 2	SET 3
a)	<b><u>HÉLICOÏDAL</u></b>		
b)	<b><u>ACIER</u></b>		
c)	<b><u>12</u></b>	<b><u>11.2</u></b>	<b><u>10.5</u></b>
d)	<b><u>80</u></b>	<b><u>80</u></b>	<b><u>79</u></b>
e)	<b><u>7</u></b>	<b><u>7</u></b>	<b><u>7</u></b>
f)	<b><u>152.5</u></b>	<b><u>152.5</u></b>	<b><u>152.5</u></b>
g)	<b><u>600 lbs/107 kg/cm</u></b>	<b><u>500 lbs/90 kg/cm</u></b>	<b><u>390 lbs/70 kg/cm</u></b>
			



# W-RACING TEAM - FUN CUP

ANNEXE III - RÉVISION 04 (24-01-2024)

Pour les moteurs essence EVO 3



7A) Triangle arrière démonté  
Dismounted rear wishbones

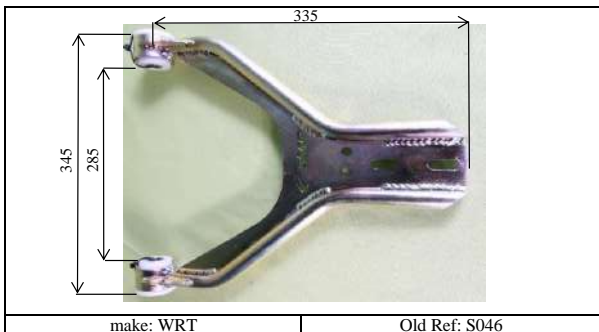

7B) Triangle avant démonté  
Dismounted front wishbones



7C) Faux cardan  
Pseudo cardan



7D) Portes-moyeu  
Hub carriers



7E) Portes-moyeu  
Hub carriers



7F) Portes-moyeu avant  
Front hub carriers



7G) Portes-moyeu avant  
Front hub carriers



7H) Porte-moyeu AVG/ARD  
Hub carrier FL/RR

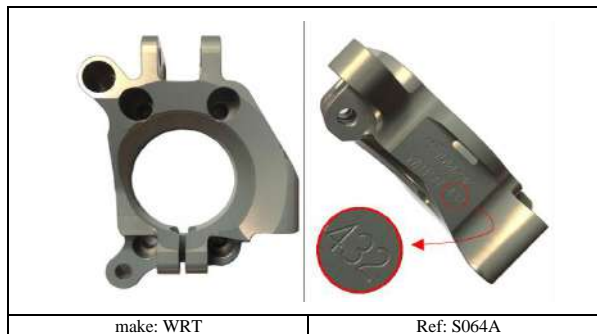

7I) Porte-moyeu AVD/ARG  
Hub carrier FR/RL

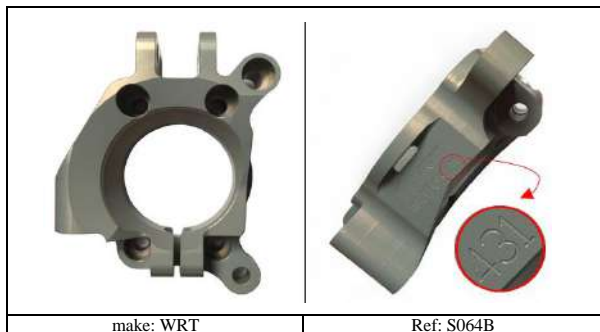

make: WRT

Ref: S064B

7J) Fixation amortisseur  
Shock absorber attachment



make: WRT

Ref: S064C

7K) Fixation Amortisseur (P-M) +1.5°  
Shock absorber attachment +1.5°



make: WRT

Ref: S064C3

7L) Fixation amortisseur montée  
Shock absorber attachment mounted



7M) Douille fixation rotule de direction  
Steering ball joint attaching socket

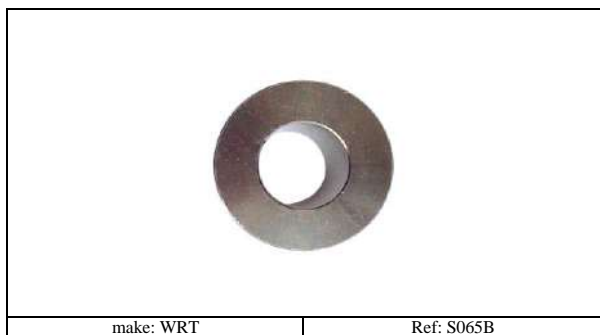

make: WRT

Ref: S065B

7N) Rondelle rotule de direction  
Steering ball joint washer



make: WRT

Ref: S065C

7O) Porte-rotule de direction  
Steering ball joint housing



make: WRT

Ref: S065A

7P) Porte-rotule de direction montée  
Steering ball joint housing mounted



AV6/ARD

AVD/ARG



# W-RACING TEAM - FUN CUP

ANNEXE III - RÉVISION 04 (24-01-2024)

Pour les moteurs essence EVO 3



7Q) Moyeu de roue (avec goujons)  
Wheel hub (with stud)



7R) Roulement  
Roller



7S) Support d'étrier avant  
Front mounting caliper



7T) Support d'étrier arrière  
Rear mounting caliper



7U) Support d'étrier avant monté  
Front mounting caliper mounted



7V) Support d'étrier arrière monté  
Rear mounting caliper mounted



7W) Porte-rotule arrière et avant  
Ball joint housing



7X) Porte-rotule avant  
Front ball joint holder

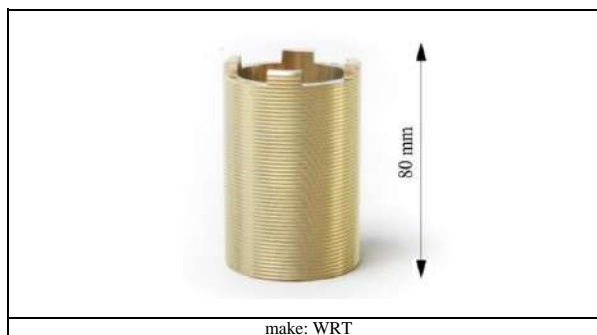

7Y) Porte-rotule arrière  
Rear ball joint holder

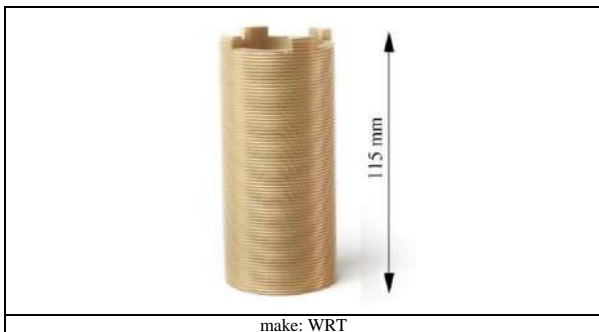

7Z) Rotules de suspension (sens de montage)  
Suspension ball joint



7AA) Cartouche d'amortisseur arrière  
Rear shock absorber

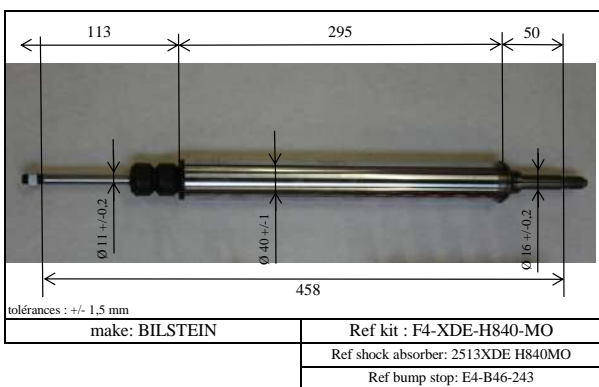

7AB) Cartouche d'amortisseur avant  
Front shock absorber



7AC) Ressort déposé  
Dismounted spring

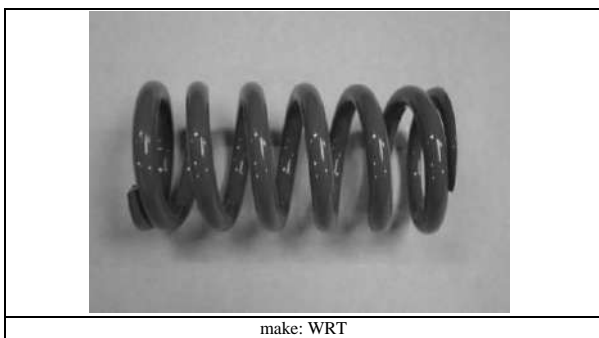

7AD) Ressort compensateur amortisseur arrière déposé  
Dismounted rear compensating spring

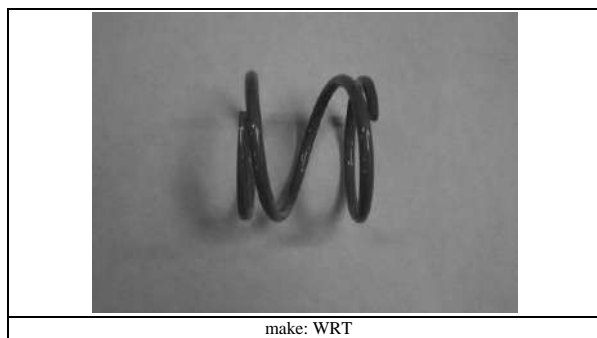

7AE) Amortisseur arrière démonté  
Rear dismounted shock absorber







# W-RACING TEAM - FUN CUP

ANNEXE III - RÉVISION 04 (24-01-2024)

Pour les moteurs essence EVO 3



7AF) Combiné fileté d'amortisseur avant

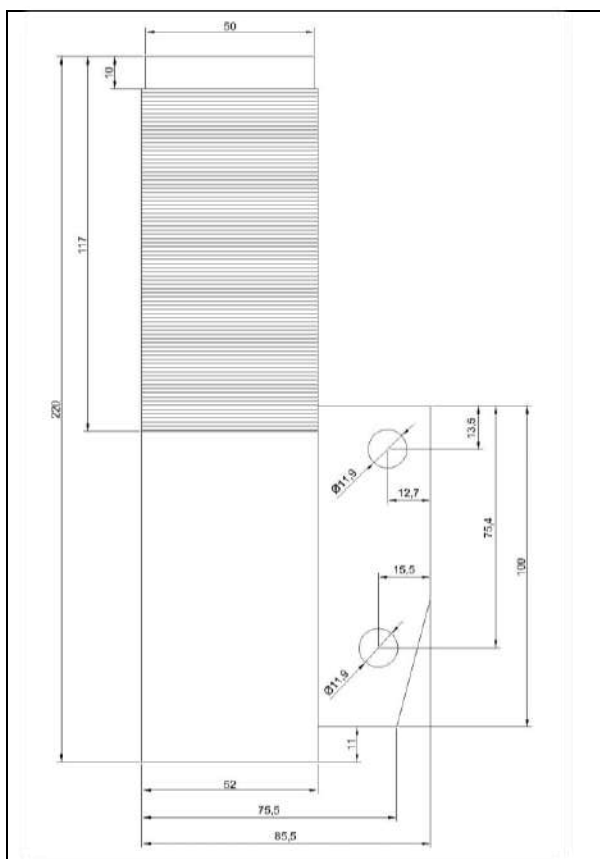

7AG) Combiné fileté d'amortisseur arrière

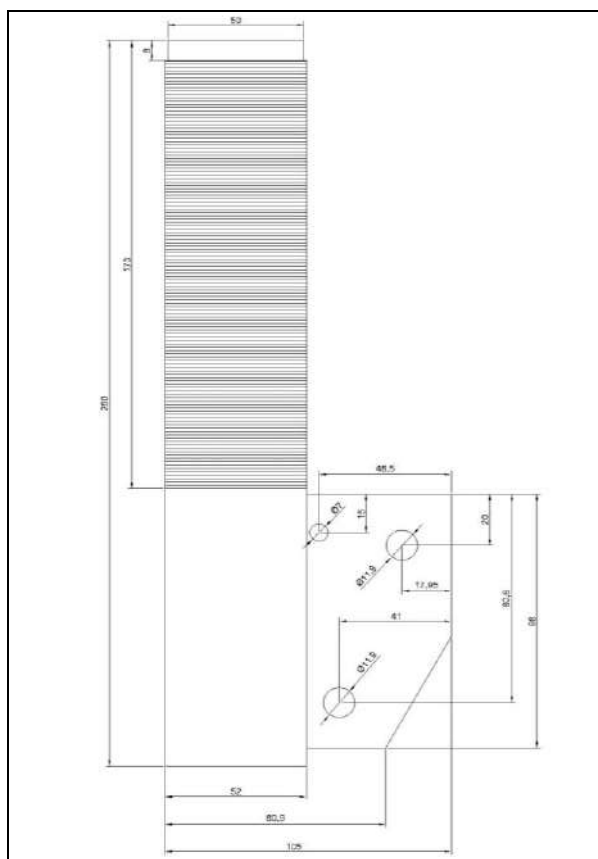

7AH) Amortisseur arrière assemblé  
Rear shock absorber



7AI) Amortisseur avant assemblé  
Front shock absorber





# W-RACING TEAM - FUN CUP

ANNEXE III - RÉVISION 04 (24-01-2024)

Pour les moteurs essence EVO 3



7AJ) Suspension avant montée  
Front mounted suspension



7AK) Suspension avant montée  
Front mounted suspension

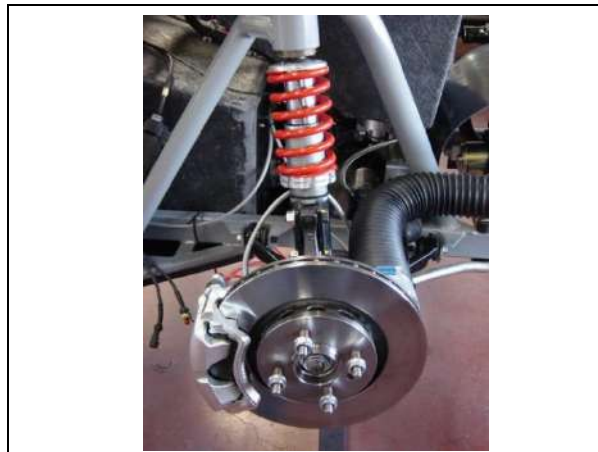

7AL) Suspension arrière montée  
Rear mounted suspension



7AM) Suspension arrière montée  
Rear mounted suspension



### 8. TRAIN ROULANT/RUNNING GEAR

#### 801. Roues Wheels

- a) Marque et type  
Make and type
- b) Diamètre  
Diameter
- c) Largeur/ET  
Width/ET
- d) Matériau  
Material
- e) Poids minimum  
Minimum weight

	Avant/front	Arrière/rear
	<b><u>BRAID FULLRACE MAXLIGHT</u></b>	<b><u>BRAID FULLRACE MAXLIGHT</u></b>
	<b><u>15 pouces/inches</u></b>	<b><u>15 pouces/inches</u></b>
	<b><u>7 pouces/inches/35</u></b>	<b><u>8 pouces/inches/20</u></b>
	<b><u>Aluminium Alloy</u></b>	<b><u>Aluminium Alloy</u></b>
	<b><u>7,3 kg +/- 100gr</u></b>	<b><u>8,0 kg +/- 100gr</u></b>
		

#### Roues Wheels

- a) Marque et type  
Make and type
- b) Diamètre  
Diameter
- c) Largeur/ET  
Width/ET
- d) Matériau  
Material
- e) Poids minimum  
Minimum weight

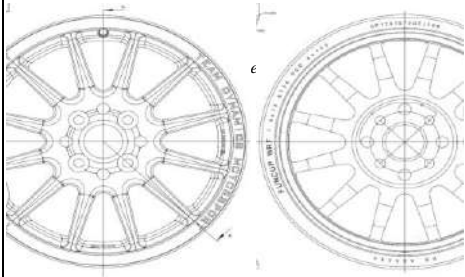
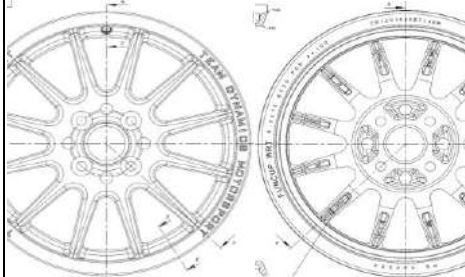
	Avant/front	Arrière/rear
	<b><u>TEAM DYNAMICS MOTORSPORT</u></b>	<b><u>TEAM DYNAMICS MOTORSPORT</u></b>
	<b><u>15 pouces/inches</u></b>	<b><u>15 pouces/inches</u></b>
	<b><u>7 pouces/inches/35</u></b>	<b><u>8 pouces/inches/20</u></b>
	<b><u>Aluminium Alloy</u></b>	<b><u>Aluminium Alloy</u></b>
	<b><u>6,9 kg +/- 100g</u></b>	<b><u>7,6 kg +/- 100gr</u></b>
		



# W-RACING TEAM - FUN CUP





ANNEXE III - RÉVISION 04 (24-01-2024)

Pour les moteurs essence EVO 3



## Roues Wheels

- a) Marque et type  
Make and type
- b) Diamètre  
Diameter
- c) Largeur/ET  
Width/ET
- d) Matériau  
Material
- e) Poids minimum  
Minimum weight
- f) Référence WRT

	Avant/front	Arrière/rear
a) Marque et type Make and type	<b><u>BRAID FULLRACE C</u></b>	<b><u>BRAID FULLRACE C</u></b>
b) Diamètre Diameter	<b><u>15 pouces/inches</u></b>	<b><u>15 pouces/inches</u></b>
c) Largeur/ET Width/ET	<b><u>7 pouces/inches/35</u></b>	<b><u>8 pouces/inches/20</u></b>
d) Matériau Material	<b><u>Aluminium Alloy</u></b>	<b><u>Aluminium Alloy</u></b>
e) Poids minimum Minimum weight	<b><u>6800 gr +/- 100 gr</u></b>	<b><u>6900 gr +/- 100 gr</u></b>
f) Référence WRT	<b><u>T027C</u></b>	<b><u>T028C</u></b>
		
		



# W-RACING TEAM - FUN CUP

ANNEXE III - RÉVISION 04 (24-01-2024)

Pour les moteurs essence EVO 3



## 802. Freins Brakes

a) Système de freinage  
Braking system

**HYDRAULIC**

b) Nombre de maîtres-cylindres  
Number of master cylinders

**2**

c) Alésages  
Bores

**1 x 17.8 mm and 1 x 19.1 mm**

d) Position des maîtres-cylindres  
Position of master cylinders

**Free**

e) Servofrein  
Servo brakes

<input type="checkbox"/>	oui yes	<input checked="" type="checkbox"/>	non non
--------------------------	------------	-------------------------------------	------------

f) Répartiteur de freinage  
Braking bias

<input checked="" type="checkbox"/>	oui (option) yes (option)	<input type="checkbox"/>	non non
-------------------------------------	------------------------------	--------------------------	------------

g) Emplacement  
Location

**BRAKE PEDAL**

	Standard version	Version 2
f) Nombre de cylindres par roue Number of cylinders per wheel	<b><u>1</u></b>	<b><u>1</u></b>
g) <b>Freins à disque</b> <b>Disc brakes</b>		
g1) <i>Nombre de plaquettes par roue</i> <i>Number of pads per wheel</i>	<b><u>2</u></b>	<b><u>2</u></b>
g2) <i>Nombre d'étriers par roue</i> <i>Number of calipers per wheel</i>	<b><u>1</u></b>	<b><u>1</u></b>
g3) <i>Épaisseur du disque neuf</i> <i>Thickness of new disc</i>	<b><u>20 mm</u></b>	<b><u>22 mm</u></b>
g4) <i>Diamètre extérieur du disque</i> <i>External diameter of the disc</i>	<b><u>239 mm</u></b>	<b><u>279 mm</u></b>
g5) <i>Diamètre ext. de frottement des plaquettes</i> <i>External diameter of pads rubbing surface</i>	<b><u>239 mm</u></b>	<b><u>279 mm</u></b>
g6) <i>Diamètre int. de frottement des plaquettes</i> <i>Internal diameter of pads rubbing surface</i>	<b><u>147 mm</u></b>	<b><u>147 mm</u></b>



# W-RACING TEAM - FUN CUP

ANNEXE III - RÉVISION 04 (24-01-2024)

Pour les moteurs essence EVO 3



8A) Étrier avant version 2  
Front caliper version 2



8B) Support d'étrier avant version 2  
Front mounting caliper version 2



8C) Disque de frein avant version 2  
Front brake disc version 2



8D) Disque de frein avant version 2  
Front brake disc version 2



8E) Plaquette de frein avant version 2  
Front brake pad version 2



8F) Frein avant monté version 2  
Mounted front break version 2



8G) Étrier version standard  
Rear caliper standard version



8H) Plaquette de frein version standard  
Brake pad standard version



8I) Disque de frein avant version standard  
Front brake disc standard version



8J) Disque de frein avant version standard  
Front brake disc standard version



8K) Frein arrière monté  
Mounted rear brake



8L) Frein arrière monté  
Mounted rear brake



8M) Étrier avec ressort du piston  
Caliper with piston spring



8N) Pompe de frein (diamètre 17,8 mm)  
Brake pump (diameter 17,8 mm)



8O) Pompe de frein (diamètre 19,1 mm)  
Brake pump (diameter 19,1 mm)



8P) Répartiteur de frein  
Brake distributor





# W-RACING TEAM - FUN CUP

ANNEXE III - RÉVISION 04 (24-01-2024)

Pour les moteurs essence EVO 3



**803. Direction  
Steering**

- a) Type  
Type
- b) Servo-assistance  
Power assisted
- c) Type d'assistance  
Power assisted type
- d) Emplacement moteur  
Power assisted location
- e) Emplacement de l'ECU direction  
ECU steering location

AVANT/FRONT	ARRIÈRE/REAR						
<b><u>RACK and PINION</u></b>	<b><u>NA</u></b>						
<table border="1"> <tr> <td style="text-align: center;">☒</td> <td style="text-align: center;">oui (option)</td> <td style="text-align: center;">non</td> </tr> <tr> <td></td> <td style="text-align: center;">yes (option)</td> <td style="text-align: center;">non</td> </tr> </table>	☒	oui (option)	non		yes (option)	non	<b><u>NA</u></b>
☒	oui (option)	non					
	yes (option)	non					
<b><u>Electric</u></b>	<b><u>NA</u></b>						
<b><u>On steering column</u></b>	<b><u>NA</u></b>						
<b><u>See pictures</u></b>	<b><u>NA</u></b>						

**8Q) Crémaillère de direction démontée  
Steering rack dismounted**

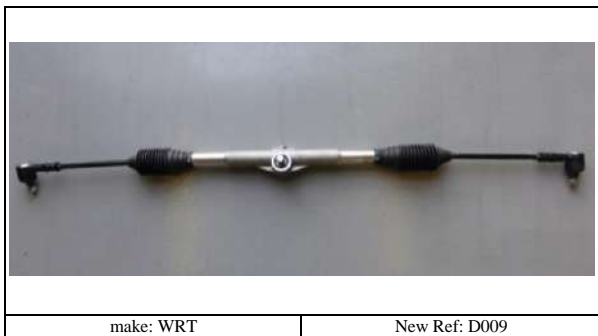

**8R) Fourreau  
Guide sleeve**



**8S) Crémaillère de direction montée  
Steering rack mounted**



**8T) Dimension support crémaillère  
Steering rack support dimensions**

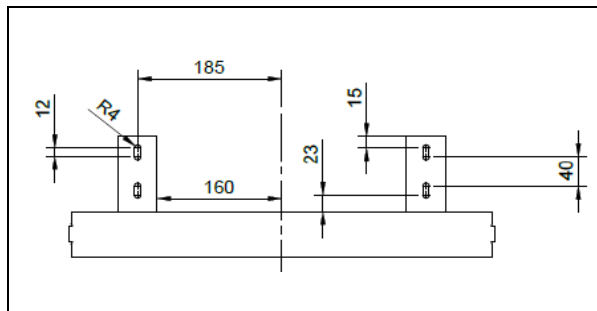

**8U) Colonne de direction démontée  
Steering column dismounted**



**8V) Barre de direction avant  
Track Rod (Front)**

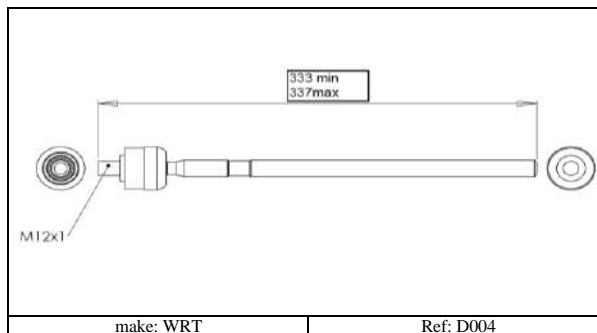



8W) Barre de pince arrière  
Track Rod (Rear)

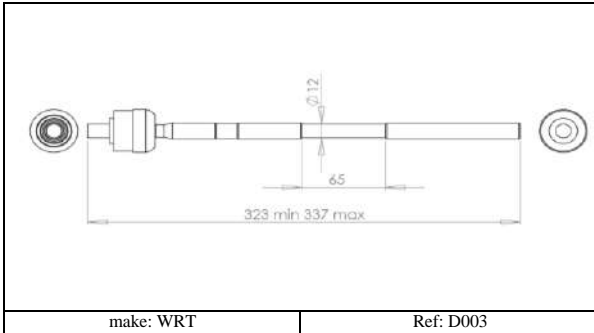

make: WRT

Ref: D003

8X) Direction assistée démontée (avec axe monoplace)  
Power assisted steering dismantled (with monoplace shaft)

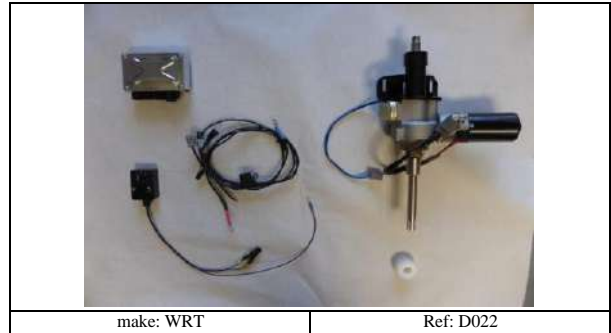

make: WRT

Ref: D022

8Y) ECU et boîtier de réglage démontés  
ECU and adjusting box dismantled

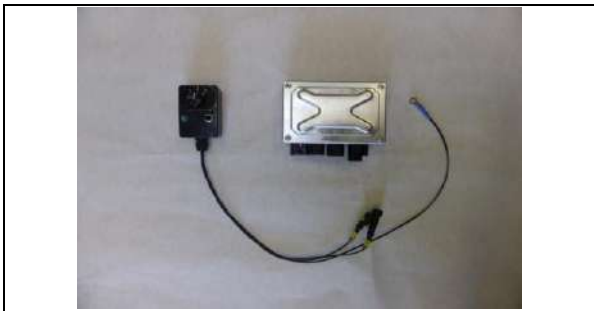

8Z) Axe monoplace (L=170 mm)  
Monoplace shaft (L=170 mm)

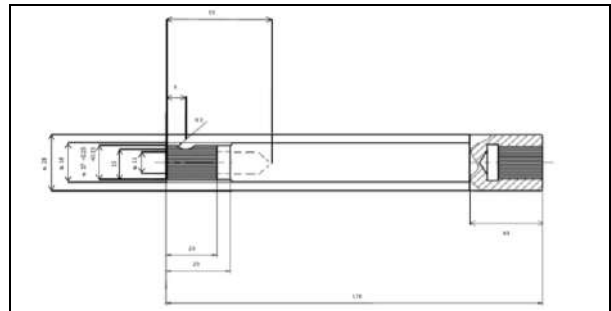

8AA) Axe biplace (L=190 mm)  
Biplace shaft (L=190 mm)

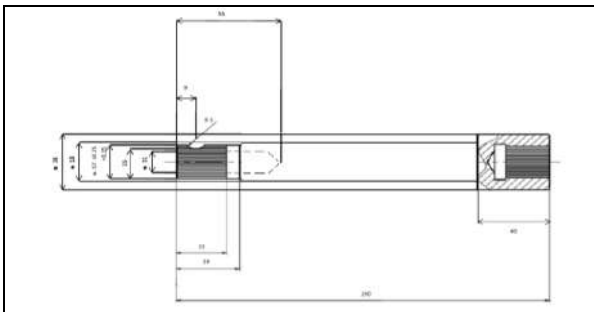

8AB) ECU monté + Boîtier de réglage monté  
ECU mounted + Adjusting box mounted

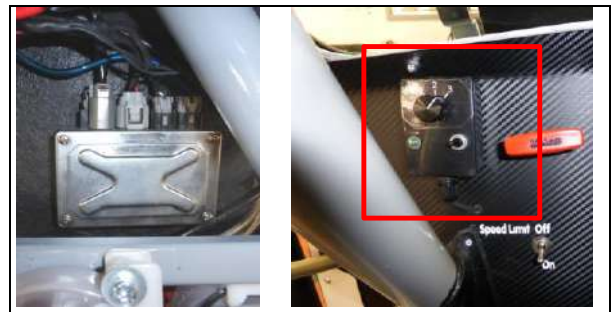

8AC) Direction assistée montée  
Power assisted steering mounted



8AD) Entretoise du porte-moyeu arrière en aluminium  
Aluminium rear hub carrier spacer

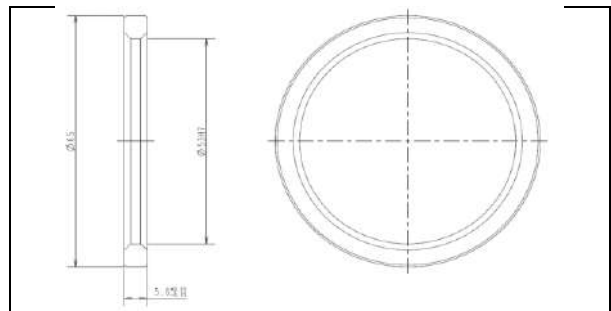



# W-RACING TEAM - FUN CUP

ANNEXE III - RÉVISION 04 (24-01-2024)

Pour les moteurs essence EVO 3



## 9. CARROSSERIE - CHÂSSIS (COQUE)/BODYWORK - CHASSIS (BODYSHELL)

### 901. Intérieur Interior

- |  |                          |            |  |            |
|--|--------------------------|------------|--|------------|
| a) Ventilation<br>Ventilation  | <input type="checkbox"/> | oui<br>yes | <input checked="" type="checkbox"/>      | non<br>non |
| b) Chauffage<br>Heating  | <input type="checkbox"/> | oui<br>yes | <input checked="" type="checkbox"/>      | non<br>non |
| c) Toit ouvrant optionnel<br>Optional sun roof                                 | <input type="checkbox"/> | oui<br>yes | <input checked="" type="checkbox"/>      | non<br>non |
| d) Type<br>Type  | <u>NA</u>                |            | e) Système de commande<br>Control system | <u>NA</u>  |
| f) Système d'ouverture des portes latérales<br>Opening system for side windows | <u>NA</u>                |            |  |            |

### 902. Extérieur Exterior

- | a) Nombre de portes<br>Number of doors                  | <u>2</u>  | b) Hayon<br>Tailgate   | <input type="checkbox"/> | oui<br>yes                               | <input checked="" type="checkbox"/> | non<br>non           |                                 |             |                                     |               |                                  |              |                      |             |                                     |               |  |  |  |  |
|---|---|--|--------------------------|--|-------------------------------------|----------------------|---------------------------------|-------------|-------------------------------------|---------------|----------------------------------|--------------|----------------------|-------------|-------------------------------------|---------------|--|--|--|--|
| c) Matériau des portières<br>Door material              | <table border="1"> <thead> <tr> <th>AVANT/FRONT</th> <th>ARRIÈRE/REAR</th> </tr> </thead> <tbody> <tr> <td><u>POLYESTER</u></td> <td><u>NA</u></td> </tr> </tbody> </table>   |  | AVANT/FRONT              | ARRIÈRE/REAR                             | <u>POLYESTER</u>                    | <u>NA</u>            |                                 |             |                                     |               |                                  |              |                      |             |                                     |               |  |  |  |  |
| AVANT/FRONT   | ARRIÈRE/REAR  |  |                          |  |                                     |                      |                                 |             |                                     |               |                                  |              |                      |             |                                     |               |  |  |  |  |
| <u>POLYESTER</u>  | <u>NA</u>   |  |                          |  |                                     |                      |                                 |             |                                     |               |                                  |              |                      |             |                                     |               |  |  |  |  |
| d) Matériau du capot avant<br>Front bonnet material     | <u>POLYESTER</u>  | e) Matériau du capot avant/arrière<br>Front/rear bonnet material | <u>POLYESTER</u>         |  |                                     |                      |                                 |             |                                     |               |                                  |              |                      |             |                                     |               |  |  |  |  |
| f) Matériau de la carrosserie<br>bodywork material      | <u>POLYESTER</u>  | g) Matériau de la lunette arrière<br>Rear window material        | <u>POLYCARBONATE</u>     |  |                                     |                      |                                 |             |                                     |               |                                  |              |                      |             |                                     |               |  |  |  |  |
| h) Matériau du pare-brise avant<br>Rear window material | <u>LAMINATED GLASS OR POLYCARBONATE</u>   |  |                          |  |                                     |                      |                                 |             |                                     |               |                                  |              |                      |             |                                     |               |  |  |  |  |
| i) Matériau des vitres latérales<br>Side widow material | <table border="1"> <thead> <tr> <th>AVANT/FRONT</th> <th>ARRIÈRE/REAR</th> </tr> </thead> <tbody> <tr> <td><u>POLYCARBONATE</u></td> <td><u>POLYCARBONATE</u></td> </tr> </tbody> </table>  |  | AVANT/FRONT              | ARRIÈRE/REAR                             | <u>POLYCARBONATE</u>                | <u>POLYCARBONATE</u> |                                 |             |                                     |               |                                  |              |                      |             |                                     |               |  |  |  |  |
| AVANT/FRONT   | ARRIÈRE/REAR  |  |                          |  |                                     |                      |                                 |             |                                     |               |                                  |              |                      |             |                                     |               |  |  |  |  |
| <u>POLYCARBONATE</u>                                    | <u>POLYCARBONATE</u>  |  |                          |  |                                     |                      |                                 |             |                                     |               |                                  |              |                      |             |                                     |               |  |  |  |  |
| j) Matériau du pare-chocs<br>Material of bumper         | <u>NA</u>   |  | <u>NA</u>                |  |                                     |                      |                                 |             |                                     |               |                                  |              |                      |             |                                     |               |  |  |  |  |
| k) Poids<br>Weights                                     | <table border="1"> <thead> <tr> <th>Éléments</th> <th>Poids minimum (nu)/Minimum weight (nude)</th> </tr> </thead> <tbody> <tr> <td><u>Lame/Front lip</u></td> <td><u>2 kg</u></td> </tr> <tr> <td><u>Capot avant/Front bonnet</u></td> <td><u>8 kg</u></td> </tr> <tr> <td><u>Partie centrale/Central part</u></td> <td><u>8,5 kg</u></td> </tr> <tr> <td><u>Capot arrière/Rear bonnet</u></td> <td><u>14 kg</u></td> </tr> <tr> <td><u>Portière/Door</u></td> <td><u>6 kg</u></td> </tr> <tr> <td><u>Aileron arrière/Rear spoiler</u></td> <td><u>2,0 kg</u></td> </tr> </tbody> </table> |  | Éléments                 | Poids minimum (nu)/Minimum weight (nude) | <u>Lame/Front lip</u>               | <u>2 kg</u>          | <u>Capot avant/Front bonnet</u> | <u>8 kg</u> | <u>Partie centrale/Central part</u> | <u>8,5 kg</u> | <u>Capot arrière/Rear bonnet</u> | <u>14 kg</u> | <u>Portière/Door</u> | <u>6 kg</u> | <u>Aileron arrière/Rear spoiler</u> | <u>2,0 kg</u> |  |  |  |  |
| Éléments  | Poids minimum (nu)/Minimum weight (nude)  |  |                          |  |                                     |                      |                                 |             |                                     |               |                                  |              |                      |             |                                     |               |  |  |  |  |
| <u>Lame/Front lip</u>                                   | <u>2 kg</u>   |  |                          |  |                                     |                      |                                 |             |                                     |               |                                  |              |                      |             |                                     |               |  |  |  |  |
| <u>Capot avant/Front bonnet</u>                         | <u>8 kg</u>   |  |                          |  |                                     |                      |                                 |             |                                     |               |                                  |              |                      |             |                                     |               |  |  |  |  |
| <u>Partie centrale/Central part</u>                     | <u>8,5 kg</u>   |  |                          |  |                                     |                      |                                 |             |                                     |               |                                  |              |                      |             |                                     |               |  |  |  |  |
| <u>Capot arrière/Rear bonnet</u>                        | <u>14 kg</u>  |  |                          |  |                                     |                      |                                 |             |                                     |               |                                  |              |                      |             |                                     |               |  |  |  |  |
| <u>Portière/Door</u>                                    | <u>6 kg</u>   |  |                          |  |                                     |                      |                                 |             |                                     |               |                                  |              |                      |             |                                     |               |  |  |  |  |
| <u>Aileron arrière/Rear spoiler</u>                     | <u>2,0 kg</u>   |  |                          |  |                                     |                      |                                 |             |                                     |               |                                  |              |                      |             |                                     |               |  |  |  |  |

9A) Lame - Vue de face  
Front lip - Front view



9B) Capot avant - Vue de face  
Front bonnet - Front view



9C) Lame avant  
Front lip

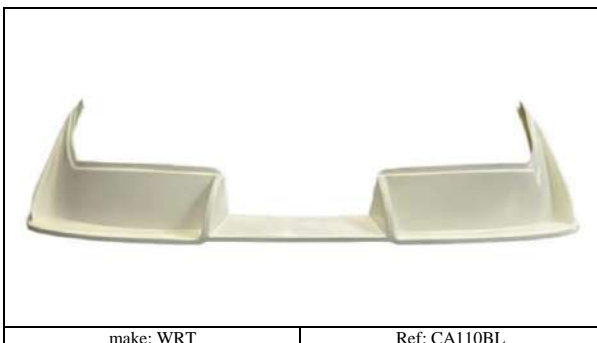

make: WRT

Ref: CA110BL

9D) Nouvelle lame  
New front lip



make: WRT/M3

Ref: CA110

9E) Capot avant - Vue 3/4 avant  
Front bonnet - Seen from 3/4 front



Ref WRT : CA109

9F) Partie centrale - Vue de face  
Central part - Front view



Ref WRT : CA022A

9G) Partie centrale - Vue 3/4 avant  
Central part - Seen from 3/4 front



9H) Capot arrière - Vue latérale  
Rear bonnet - Side view



Ref WRT : CA020

9I) Capot arrière - Vue arrière  
Rear bonnet - Rear view



9J) Portière droite  
Right door



Ref WRT : CA081

9K) Aileron arrière - Vue de face  
Rear spoiler - Front view

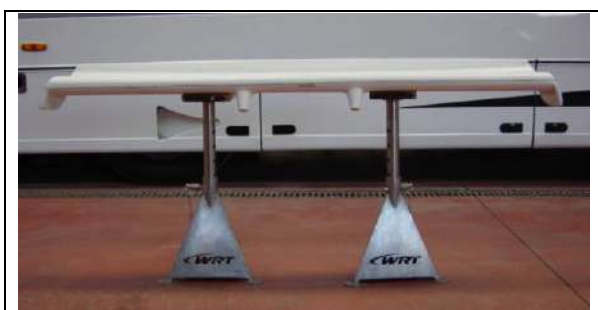

Ref WRT: CA002

9L) Support d'aileon renforcé  
Reinforced rear Wing Support



Ref WRT : CA090

9M) Support aileron arrière - Vue 3/4 gauche  
Rear spoiler support - 3/4 left view



9N) Support aileron arrière - Vue 3/4 droit  
Rear spoiler support - 3/4 right view



9O) Support aileron arrière - Vue arrière  
Rear spoiler support - rear view



9P) Passage de Roue avant gauche et droit  
Wheel Arch Panel (left and right Front)

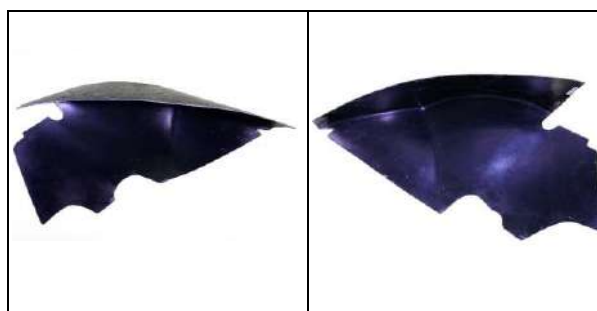

CA076

CA075

- 9Q) Passage de roue arrière gauche et droit  
Wheel Arch Panel (left and right Rear)

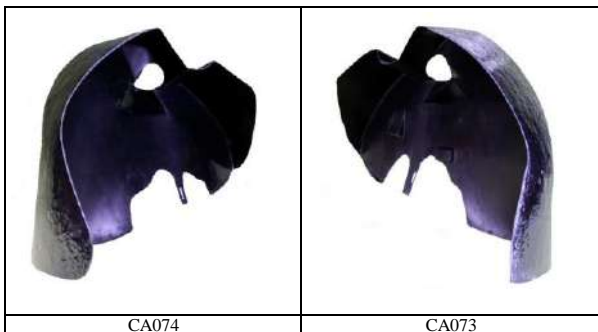

CA074

CA073

- 9R) Planche de bord non équipée  
Not fitted dash panel



- 9S) Fond plat  
Undertray



Ref WRT : CA050

- 9T) Dimension générale d'une Fun Cup  
General dimensions of a Fun Cup

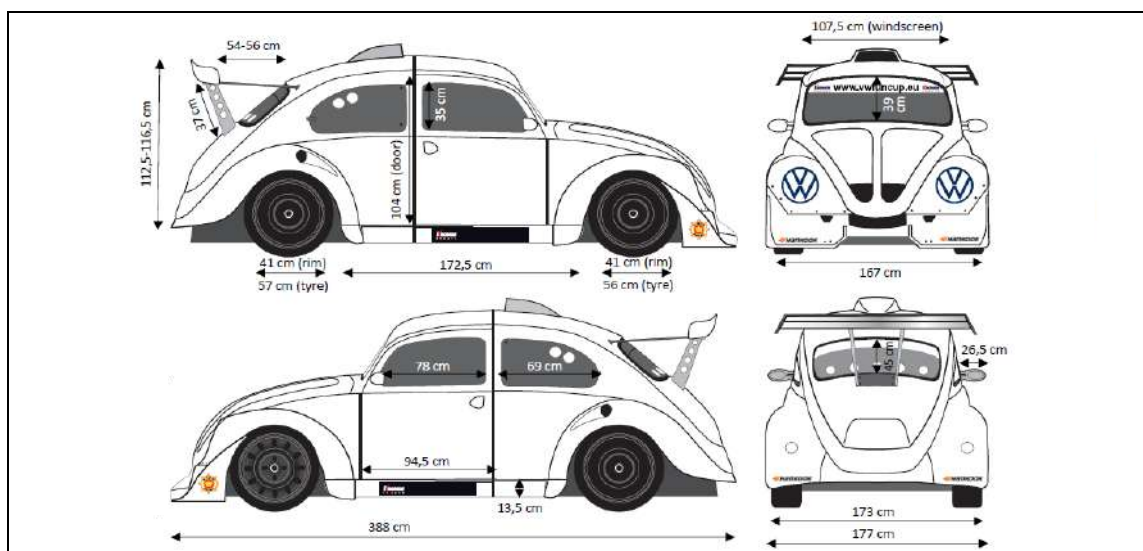

**Une tolérance de +/- 1% est autorisée**

**A tolerance of +/- 1% is permitted**

**903. Châssis (coque)  
Chassis (bodyshell)**

9U) Châssis monoplace version 1 (plus valable à partir du 01/01/2019)  
Single seat chassis version 1 (will not be valid anymore from 01/01/2019)

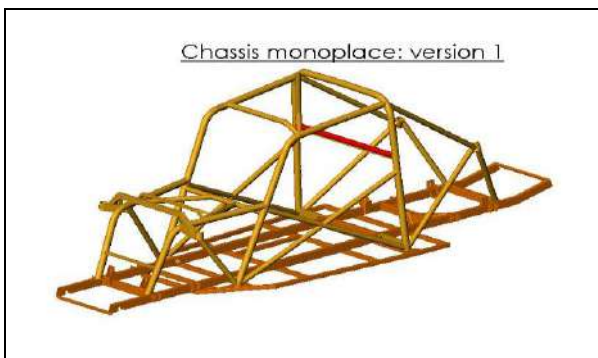

9V) Châssis monoplace version 2 (plus valable à partir du 01/01/2025)  
Single seat chassis version 2 (will not be valid anymore from 01/01/2025)

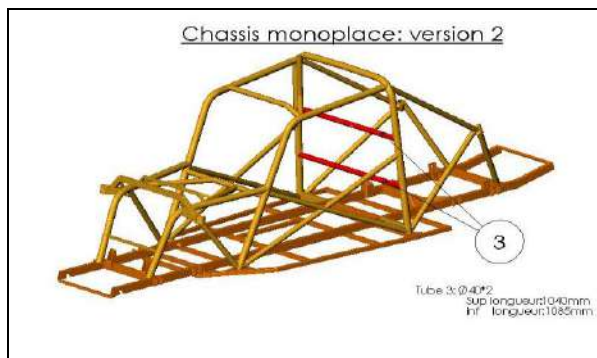

9W) Châssis monoplace version 3  
Single seat chassis version 3

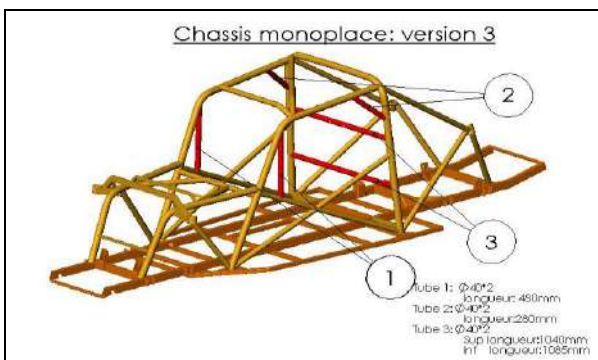

9X) Châssis monoplace version 4  
Single seat chassis version 4

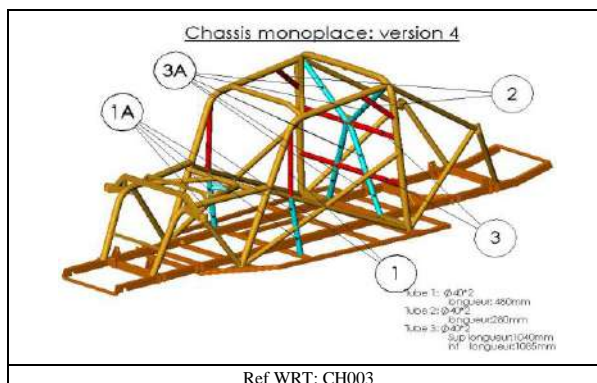

9Y) Châssis biplace version 1 (plus valable à partir du 01/01/2019)  
Two-seater chassis version 1 (will not be valid anymore from 01/01/2019)

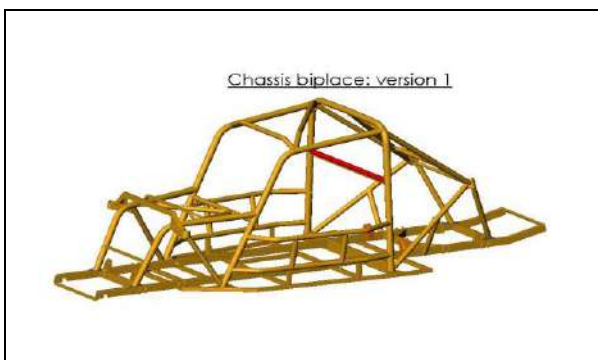

9Z) Châssis biplace version 2 (plus valable à partir du 01/01/2025)  
Two-seater chassis version 2 (will not be valid anymore from 01/01/2025)

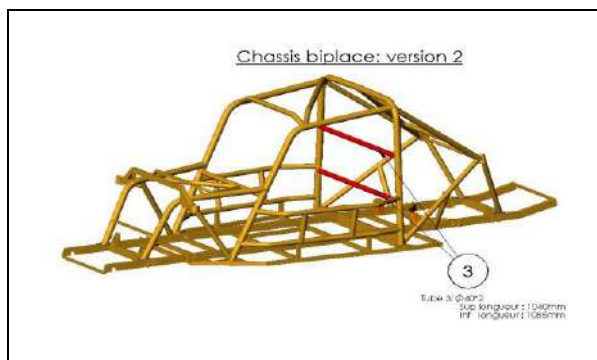

9AA) Châssis biplace version 3  
Two-seater chassis version 3

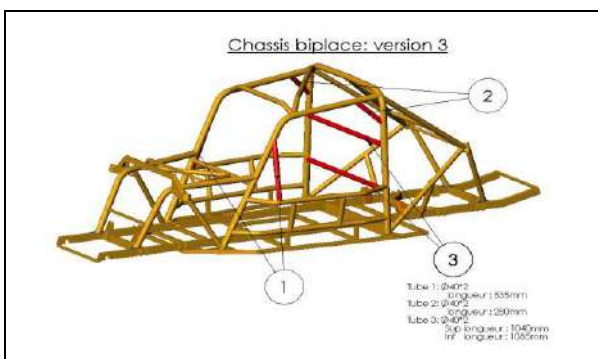

9AB) Châssis biplace version 4  
Two-seater chassis version 4

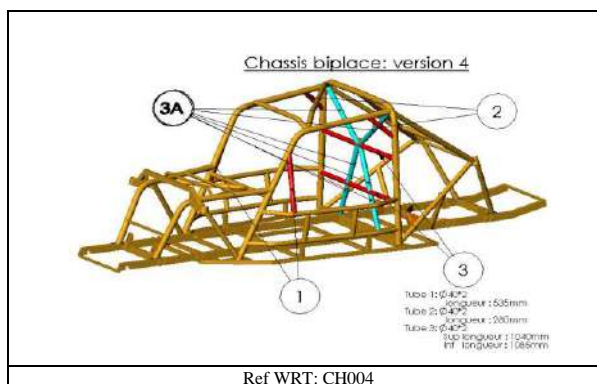

9AC) Modification châssis pour carter moteur FSI  
Frame modification for engine's carter FSI

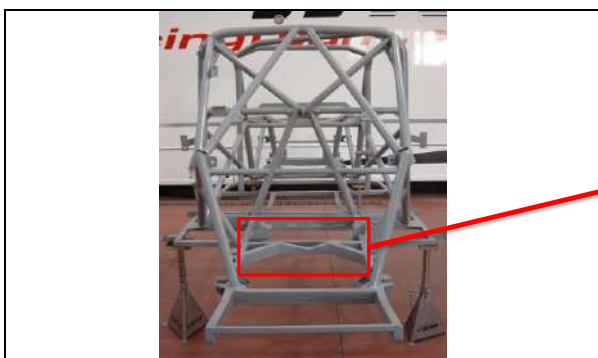

9AD) Modification châssis pour carter moteur FSI  
Frame modification for engine's carter FSI



9AE) Support de filtre à air (version 1)  
Air filter's support (version 1)



9AF) Support de filtre essence (version 1)  
Fuel filter's support (version 1)



9AG) Support de filtre à air (version 2)  
Air filter's support (version 2)



9AH) Support de filtre essence (version 2)  
Fuel filter's support (version 2)



### 10. ÉQUIPEMENT OPTIONNEL/OPTIONAL EQUIPMENT

#### 1001. Powerboard E-RACE

10A) Powerboard  
Powerboard



10B) Powerboard montée  
Powerboard mounted



10C) Faisceau cockpit  
Cockpit loom



10D) Faisceau avant  
Front loom



10E) Faisceau auxiliaire avant  
Secondary front loom



10F) Faisceau arrière  
Rear loom





10G) Faisceau auxiliaire arrière  
Secondary rear loom



make: WRT

Ref: E124

10H) Supports powerboard  
Powerboard supports

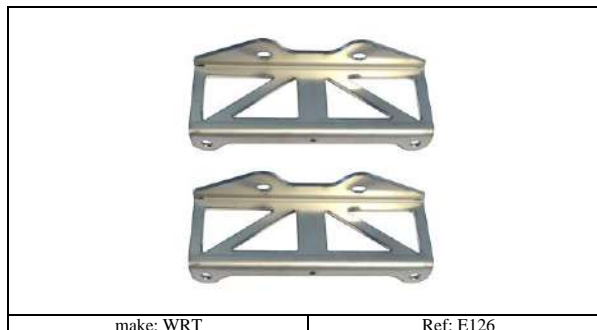

make: WRT

Ref: E126

10I) Cadre powerboard  
Powerboard support frame

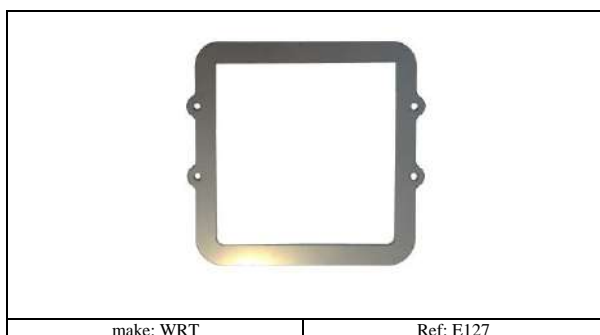

make: WRT

Ref: E127

10J) Bouton start engine  
Engine start button



make: WRT

Ref: E128

10K) Interrupteur allumage  
Switch ignition



make: WRT

Ref: E129

10L) Interrupteur coupe-circuit extérieur  
External circuit-breaker switch



make: WRT

Ref: E131

10M) Rallonge faisceau essuie-glace  
Extension wiper loom

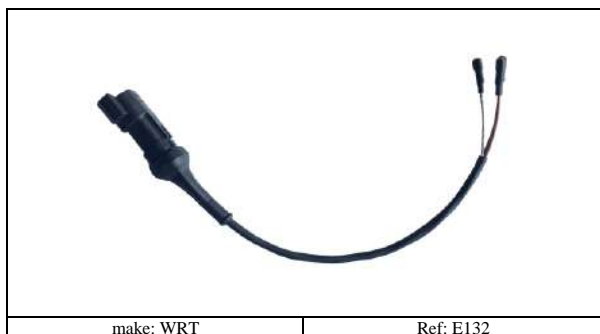

make: WRT

Ref: E132

10N) Rallonge faisceau radio  
Extension radio loom



make: WRT

Ref: E133



# W-RACING TEAM - FUN CUP

ANNEXE III - RÉVISION 04 (24-01-2024)

Pour les moteurs essence EVO 3



## 1002. Powerboard MoTec

100) Powerboard  
Powerboard

1) Marque Brand	<b><u>MoTec</u></b>
2) Modèle Type	<b><u>PDM 15</u></b>
3) Référence WRT WRT Part Number	<b><u>M011G</u></b>



1) Marque Brand	<b><u>MoTec</u></b>
2) Modèle Type	<b><u>PDM 30</u></b>
3) Référence WRT WRT Part Number	<b><u>M011J</u></b>



10P) Keypad 8 boutons  
8 button keypad

1) Marque Brand	<b><u>MoTec</u></b>
2) Modèle Type	<b><u>Keypad 8</u></b>
3) Référence WRT WRT Part Number	<b><u>M011I</u></b>



10Q) Faisceau PDM A  
PDM A Loom

1) Marque Brand	<b><u>WRT</u></b>
2) Référence WRT WRT Part Number	<b><u>E121A</u></b>



10R) Faisceau PDM B  
PDM B Loom

1) Marque Brand	<b><u>WRT</u></b>
2) Référence WRT WRT Part Number	<b><u>E121B</u></b>

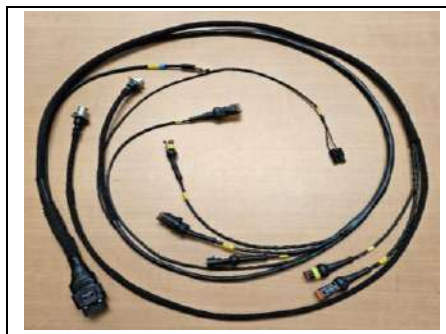



# W-RACING TEAM - FUN CUP

ANNEXE III - RÉVISION 04 (24-01-2024)

Pour les moteurs essence EVO 3



## Table des matières / Table of contents

<b>1. GÉNÉRALITÉS / GENERAL</b>	<b>1</b>
101. Constructeur / Manufacturer	1
102. Dénomination commerciale / Commercial name	1
103. Cylindrée / Cylinder capacity	1
104. Mode de construction / Type of car construction	1
105. Nombre de volumes / Number of volumes	1
106. Nombre de places / Number of places	1
<b>2. DIMENSIONS, POIDS / DIMENSIONS, WEIGHT</b>	<b>1</b>
201. Longueur hors-tout / Overall length	1
202. Largeur hors-tout / Overall width	1
203. Endroit de mesure / Where measured	1
204. Largeur de carrosserie / Width of bodywork	1
205. Empattement / Wheelbase	1
206. Porte-à-faux / Overhang	1
207. Distance "G" (volant - paroi de séparation arrière) / Distance "G" (steering wheel - rear bulkhead)	1
<b>3. MOTEUR / ENGINE</b>	<b>2</b>
301. Emplacement et position du moteur / Location and position of the engine	2
302. Rapport volumétrique / Volumetric ratio	2
303. Cycle / Cycle	2
304. Suralimentation / Supercharging	3
305. Nombre et disposition des cylindres / Number and layout of cylinders	3
306. Mode de refroidissement / Type of cooling	3
307. Cylindrée / Cylinder capacity	4
308. Matériau du bloc-cylindres / Cylinder block materiel	4
309. Chemises / Sleeves	4
310. Alésage / Bore	4
311. Course / Stroke	4
312. Piston / Piston	4
313. Bielle / Connecting rods	5
314. Vilebrequin / Crankshaft	5
315. Volant moteur / Flywheel	6
316. Culasse / Cylinder head	7
317. Épaisseur du joint de culasse / Thickness of cylinder head gasket	7
318. Alimentation par injection/Fuel feed by injection	8
319. Arbre à cames/Camshaft	17
320. Admission / Intake	18
321. Boîtier papillon/Throttle valve housing	19
322. Échappement/Exhaust	19
323. Système d'allumage/Ignition system	20
324. Radiateur d'eau moteur/Engine water radiator	21
325. Refroidisseur d'eau/Water cooling	22
326. Système de lubrification/Lubrication System	22
327. Support moteur/Engine mount	23
<b>4. CIRCUIT DE CARBURANT/FUEL CIRCUIT</b>	<b>24</b>
401. Réservoir et accessoires/Fuel tank and accessories	24
<b>5. ÉQUIPEMENT ÉLECTRIQUE/ELECTRICAL EQUIPMENT</b>	<b>26</b>
501. Batterie / Battery	26
502. Alternateur/Alternator	26
503. Poulie damper/Damper pulley	27
504. Démarreur et composants électriques/Starter and electrical components	28
505. Rampe de phares/Headlamp ramp	29
<b>6. TRANSMISSION / POWER TRAIN</b>	<b>30</b>
601. Roues motrices/Driven wheels	30
602. Embrayage/Clutch	30
603. Boîte de vitesse/Gearbox	31
604. Refroidissement boîte de vitesse/Gear box cooling	31
605. Changement de vitesse au volant/Paddle shift	32
606. Changement de vitesse avec stick/Gear change with lever	33
607. Couple final/Final drive	33
608. Arbres de transmission/Transmission shaft	35
<b>7. SUSPENSION / SUSPENSION</b>	<b>36</b>
701. Généralités/General	36
702. Ressorts hélicoïdaux/Helicoidal springs	36
703. Ressorts à lames/Leaf springs	36
704. Barres de torsion/Torsion bars	36
705. Autre type de suspension/Other type of suspension	36
706. Amortisseur/Shock absorbers	36
707. Type de ressorts/Type of springs	36
<b>8. TRAIN ROULANT/RUNNING GEAR</b>	<b>43</b>
801. Roues / Wheels	43
802. Freins/Brakes	45
803. Direction / Steering	48
<b>9. CARROSSERIE - CHÂSSIS (COQUE) / BODYWORK - CHASSIS (BODYSHELL)</b>	<b>50</b>
901. Intérieur/Interior	50
902. Extérieur/Exterior	50
903. Châssis (coque)/Chassis (bodyshell)	54
<b>10. ÉQUIPEMENT OPTIONNEL/OPTIONAL EQUIPMENT</b>	<b>56</b>



# W-RACING TEAM - FUN CUP

ANNEXE III - RÉVISION 04 (24-01-2024)

Pour les moteurs essence EVO 3



## NOTES/NOTES

A large area of the page is filled with horizontal dotted lines, providing space for handwritten notes.